

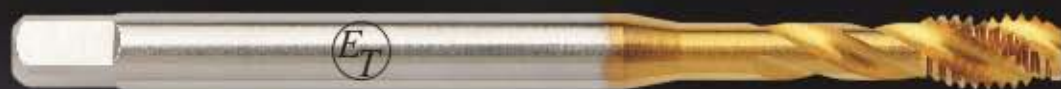

EMKAY TOOLS



M I S S I O N



We strive continuously to provide total solutions for threading application in order to satisfy our customers and to increase their productivity by supplying the right tap that suits their applications.

About Us

Our endeavor is to continuously offer total solutions in threading applications, in order to delight our customers and increase their productivity by supplying the right tap for their specific applications.

Established over 25 years ago, Emkay has emerged as a leader in the thread cutting tools domain by offering superior value to its customer. Ensuring the right product for each customer specific production requirement and timely deliveries have given us a tremendous competitive advantage in this high-precision industry. Emkay realizes that a prerequisite imperative to implementing ideas are the right thread cutting tools, without which manufacturing is impossible. We ensure a consistent supply of high quality and high performance thread cutting tools to not just satisfy our customer requirements but also contributing to technical evolution. This is done by advising and guiding them from the initial idea to executing the specific application effectively and productively.

With a stock of over 7500 different sizes and styles, Emkay has become Tap industry's benchmark for quality and performance. This coupled with our expertise of working together with the user industry to arrive at solutions and improvements in tapping requirement has positioned Emkay as a solution provider in the domain. Partnering with Emkay offers the customer access to its massive data bank of successful operations with every conceivable material in wide spectrum of tapping parameters. Emkay advancement in cutting tool design and productions have resulted in very high quality thread cutting taps, setting new standards in productivity and performance in cutting of alloys, stainless steels and difficult to machine materials.

At Emkay, we have gained our customers' trust and supports through our total commitment to consistent technological advancement. A continuous efforts to improve on our past achievements has been made by implementing Kaizen, virtually on daily basis for the evolving technological advancement in tapping applications.





EMKAY TOOLS has the latest and one of the largest manufacturing facility of H.S.S. Taps in the country, which conforms to the best International Manufacturing Standards.

Latest CNC Thread Grinding machines for Thread Grinding.



Latest CNC Flute Grinding machines for Flute Grinding.

CNC machines for manufacturing high performance taps ensure quality of taps is uniformly consistent to the last piece throughout the entire batch.





In house heat treatment facility is closely monitored using latest controls and gadgets.

Engineering and production planning departments monitors continuously various production processes for timely deliveries of taps to cutomers.



Vigorous quality control measures are strictly adhered at every stage of of manufacturing and final inspection.

Quality Assurance department ensures consistency in quality of taps resulting in high performance during tapping operation at customer's end.





Large inventory of all types of commonly used steel for taps ensures fast delivery.

With more than 7500 varieties ex-stock, Emkay Tools is in a position to deliver taps to the customer just-in-time.



Emkay Tools team comprises of highly trained engineers and skilled manpower dedicated to developing highest quality ground thread taps for use in today's most aggressive conditions.



TABLE OF CONTENTS

A) EMKAY HIGH PERFORMANCE TAPS & NEW DEVELOPMENTS	1-7
B) SELECTION CHART FOR EMKAY HIGH PERFORMANCE TAPS	8-10
C) PRODUCT RANGE	11-36
1. MC	12-16
2. MF	17-20
3. UNC	21-23
4. UNF	24-26
5. BSW	27-29
6. BSF	30-31
7. NPS/ NPSF	32
8. NPT/NPTF	33
9. BSP/BSPT	34
10. HELICOIL STI Tap	35
11. NIB Tap	36
D) TECHNICAL INFORMATION AND GUIDELINES	37-51
1. NOMENCLATURE OF THREAD SYMBOLS	38
2. STEEL FOR TAP	39
3. SURFACE COATING	39
4. TOLERANCE FOR SCREWING TAPS & CLASS OF FIT FOR ISO METRIC THREADS	40
5. DRILL SELECTION CHART	41-42
6. CUTTING SPEED	43-44
7. LUBRICANTS FOR TAPPING	45
8. GENERAL SUGGESTIONS CONCERNING DO & DONT'S FOR TAPPING	46
9. TAP TROUBLE SHOOTING	47-49
10. GUIDE TO THREAD FORMING TAP	50-51



HI-PERFORMANCE TAPS (HSS + 5% COBALT)

These are manufactured out of HSS-E steel (5% Cobalt). The advantages of these over conventional HSS (M2) taps are as follows:

HI-Performance Taps Last Longer Than Conventional Taps and are designed to provide maximum machining efficiency for high quality and high volume thread production.

HI-Performance Taps cut Faster than conventional Taps. Tests over years have proved that HI- Performance Taps have considerably longer life, even when the taps are run Comparatively Faster.

HI-Performance Taps are the outcome of special tool geometry, engineered to optimize the benefits of premium steel and specialized coatings like TiN, TiCN, TiALN.

HI-Performance Taps are precision ground on CNC thread grinders for consistent and close thread tolerances.

HI-Performance Taps cut down cycle time and frequency of tool change, thereby decreasing the overall cycle time in CNC machines.





HI-PERFORMANCE THREAD FORMING TAPS

(A DIFFERENT WAY OF PRODUCING INTERNAL THREADS)



These taps are designed for machine tapping in ductile materials. Also known as Cold Forming Tap, Roll Forming Tap Or Fluteless Tap, HI-Performance Thread Forming Tap have no flutes or cutting edges but have special roll forming lobes with circular lands and short taper leads for through or blind holes. Since the displacement of metal has to be considered, specially calculated tapping drill sizes are necessary.

For tapping depths, more than twice the tap diameter, Roll Taps with oil grooves are recommended. These grooves provide a passage for the lubricant and also for the escape of air and oil to avoid a piston effect in blind holes.

Please refer to page no.50 & 51 for detailed description about Thread Forming Taps.



HI-PERFORMANCE SPIRAL FLUTED TAPS

(FOR BLIND HOLE TAPPING)



Spiral Fluted Taps are designed primarily for machine tapping in blind holes. They are suitable for tapping in soft materials such as aluminium and soft steels, which produce long and stringy chips. The shear action provided by the spiral flutes draws the chip out of the hole, allowing greater depth of threading without chip clogging.



HI-PERFORMANCE SPIRAL POINTED TAPS

(FOR THROUGH HOLE TAPPING)



Emkay Tools specializes in application taps for various applications. Spiral Point Tap Or Gun Nose Tap with 3-4 threads chamfer is recommended for tapping in THROUGH HOLES. These taps normally push the chips down the hole and are suitable for materials like aluminium, stainless steel, general purpose steel, forged steel etc.



HI-PERFORMANCE TAPS FOR CAST IRON TAPPING



Emkay Tools has developed application taps for Cast Iron Tapping, having a special geometry and thread tolerance which is suitable for tapping in Cast Iron and also in short chipping S.G. Iron. These taps have chamfer of 2 thread lengths and can be used for both through holes and blind holes.



HI-PERFORMANCE NIB/NUT TAPS FOR NUT TAPPING





Emkay Tools Nib Taps are specially made for automatic tapping of nuts in high speed Nut Tapping Machines in materials like stainless steel etc. These taps have appropriate geometry and flute profile which deliver high quality and consistency in threading. They can also be designed to specific tolerances and applications to suit customers' working conditions.



HI-PERFORMANCE SPECIAL TAPS & THREAD MILLING CUTTERS



In addition to standard range of Taps,  also manufactures Taps as per drawings, special dimensions & tolerance class on specific request from a customer.  also manufactures Thread Milling Cutters.

New Developments



PM Taps

Powder metallurgy high speed steel grade is a premium steel engineered for hardness, wear resistance, tool life, heat resistance, toughness, strength and performance under difficult cutting conditions with higher cutting speeds for increased productivity.

APPLICATION :

- (a) **ALLUMINIUM** : Recommended for all types of aluminium alloys.
- (b) **EXOTIC ALLOYS** : Recommended for steels, steel alloys, stainless steels, titanium alloys, nickel and nickel base alloys and other exotic alloys.
- (c) **HARD MATERIALS** : Recommended for harder (32Rc-45Rc) materials including steel alloys, titanium alloys, nickel base high temperature alloys, tool and mold steels, and stainless steels.
- (d) **CAST IRON** : Recommended for all types of gray, ductile and malleable cast iron, Emkay has started manufacturing high performance taps in superior grade powder metallurgy high speed steel. Emkay is now maintaining stock of superior grade powder metallurgy high speed steel taps in all standard sizes, mainly in metric sizes ranging from 3 mm to 14 mm. These taps are available in the following varieties:
 - a. Fluteless Taps for blind & through hole in ductile materials.
 - b. Spiral Pointed Taps for through hole application
 - c. C.I. Taps for Cast Iron applications.
 - d. Spiral Fluted Taps for blind hole application.

We are also manufacturing different varieties in superior powder metallurgy high speed steel for user-specific applications on request.



Carbide Taps

The structure of carbide is very stable with consistent sub-micro grain particles and hard in nature with character, more resistant to abrasion, pressure, heat, and material adhesion. Carbide is more brittle, therefore contributory factors to success or failure may comprise of the following : rigid work piece - rigid tapping avoiding shock or undesirable "float" - vibration. Carbide Taps offers a longer/faster and more consistent performance in specific application.

APPLICATION :

- (a) High volume production in materials with abrasive qualities like cast iron and aluminium - silicon alloys (Si > 10%).
- (b) Materials which exhibit high wear characteristics or a "closing" nature. Composites - pure alloys such as tungsten, copper, etc - "exotics" - iron - alum alloys.
- (c) Materials hardened above Rc40. Steels and "exotic" alloys
 has started the manufacture of Carbide Taps and at the moment are manufacturing different varieties of Carbide Taps against specific requests from customers.



Through Coolant Taps (T.C.H)

The performance of Taps with Through Coolant Holes is higher than the same taps used with external lubrication. These kinds of taps allow better evacuation of the chip which is transported away from the cutting area itself. Wear on the cutting edge is reduced, since the cooling effect on the cutting zone is higher than the heat generation. T.C.H. Taps give excellent performance while tapping deep blind holes up to $3 \times D$. The advantages of T.C.H Taps over Conventional Machine Tap are increased tool life and a reduction in cycle times, cleaner cut threads, accurate dimensions, increased production with more tapped holes per tool resulting in lower machining cost per part.

Lubrication can be oil, emulsion or air pressurized with oil mist. Working pressure of not less than 12 - 15 bar is required.

APPLICATION :

T.C.H Taps are used for a variety of challenging applications involving tough, abrasive materials.

Through Coolant Taps with Axial hole : For blind hole tapping

Through Coolant Taps with Radial holes : For through hole tapping



Through Coolant Taps with Radial holes : For Through Hole Tapping

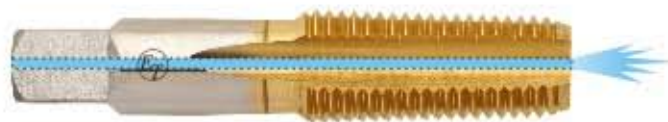

Through Coolant Taps with Axial hole : For Blind Hole Tapping

Emkay has started manufacturing T.C.H High Performance Taps in HSS-E and superior grade PM- Powder Metallurgy high speed steel. These taps are available in the following varieties:

- Fluteless Taps for blind & through holes in ductile materials.
- Spiral Pointed Taps for through hole application.
- C.I. Taps for Cast Iron applications.
- Spiral Fluted Taps for Blind hole application.

Emkay at the moment is manufacturing different varieties of T.C.H taps against specific requests from customers.

Taps Confirming To Japanese Industrial Standard Specification (JIS)



Emkay the leader in tapping technology for more than 40 years has launched a new range of High Performance JIS Taps for tapping applications adhering to Japanese standards for companies manufacturing products as per Japanese Industrial Standard Specification (JIS). The new Emkay JIS Taps are available in Cutting as well as Cold-Forming Taps with general dimensions in accordance with Japanese standards to produce threads with JIS Class tolerance.

Recognizing the highest standards followed by Japanese automotive manufacturing, Emkay offers the best available option to achieve highest standards in tapping application through its range of JIS Taps.



With Emkay's four decades of expertise and excellence in tapping technology, this new range of high quality Taps are available in a variety of geometries and styles that will produce threads in a broad range of materials from steel, stainless steel, cast and non-ferrous, to titanium and titanium alloys, nickel and nickel-base and cobalt-base alloys with both short-chipping and long-chipping in through-or blind-hole applications. Emkay also provides a JIS tap ideally suited for producing threads in cast iron, as well as abrasive cast iron with vermicular graphite.

Emkay JIS Cold forming taps are ideal for the chip - less production of internal threads in blind- or through-holes which has excellent stability, especially with small thread sizes.

Emkay JIS Taps include sizes ranging from M3 to M12 in straight-flute, spiral point, slow and fast-spiral flute, CI and Fluteless Tap. The JIS taps are also available with advanced coatings to suit material and tapping applications.

Emkay JIS taps are also available with an internal coolant-lubricant supply in both Axial and Radial T.C.H. as per application on request.



SELECTION CHART FOR EMKAY HIGH PERFORMANCE TAPS

GUIDANCE CHART FOR TAP SELECTION AS PER APPLICATION

● First Choice
 ■ Second Choice



APPLICATION		HARDNESS HB		TENSILE STRENGTH N/mm ²		CUTTING SPEED M/Min.		TYPE OF COOLANT		Through Hole			Blind Hole			Through or Blind Hole												
		BRIGHT	TIN/TICN	BRIGHT	TIN/TICN	BRIGHT	TIN/TICN			BRIGHT	TIN	TICN/TIALN	A Bright	C Bright	D Bright	Bright	TIN	TICN/TIALN	Bright	TIN	TICN/TIALN							
Steel	Low Alloy Steel, Structural Steel	<200	<700	20	40	Sulfo- or chlorinated oil		●	●	●	●	●	●	■	■	■	■	■	■	■	■	■	●	●	●	●	●	●
	Plain Carbon Steel, Alloy Steel & Steels With Good Machinability	<250	<850	15	32	Sulfo- or chlorinated oil		●	●	●				●			●	■	■	■			■	●	●	■	●	●
Stainless Steels	Free Machining Stainless Steel	<250	<850	8	12	Sulfo- or chlorinated oil								●	●								●	●	●	●	●	●
	Austenitic Ferritic AISI 304,316,321																						●	●	●	●	●	●
Cast Iron	Grey Cast Iron	<150	<700	15	20	Dry, air jet or soluble oil																	●	●	●			
	Malleable Cast Iron	<200	<700	8	15	Soluble oil or chemical-type coolant																	●	●	●			
Copper & Its Alloys	Soft	<100	<350	12	20	Light base oil					■			●									●	●	●	●	●	●
	Hard	<200	<700	25	40	Light base oil											■	■	■									
Brass	Short Chipping	<200	<700	30	45	Soluble oil, light duty oil						●																
	Long Chipping	<200	<700	20	40	Soluble oil, light duty oil					■	●			●								●	●	●	●	●	●
Bronze	Short Chipping	<300	<700	4	--	Soluble oil, light duty oil					●																	
	Long Chipping	<200	<700	20	30	Soluble oil, light duty oil					●												■	■	■	■	■	■
Aluminium	Short Chipping Si < 10%	<120	<400	20	35	Water soluble or oil/chemical especially for aluminium					■	■	●	■	■	■							●	●	●			
Magnesium	Short Chipping Si > 10%	<120	<400	15	30	Water soluble or oil/chemical especially for aluminium					●												●	●	●			
	Long Chipping unalloyed	<100	<350	16	30	Oil specially recommended for magnesium					■	■	■	■	■	■							●	●	●	●	●	●
	Medium Chipping Si < 0.5%	<150	<500	30	50	Oil specially recommended for magnesium					■	■	■	■	■	■							●	●	●	●	●	●
Zinc alloys				20	40	Soluble oil																		●	●		●	●

Types of Holes

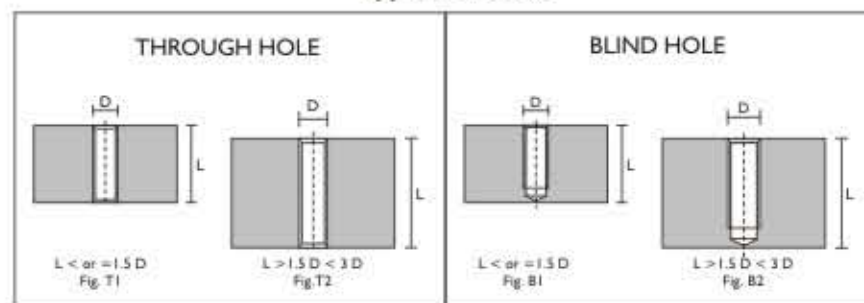

How to find the right tap ?

- Material to be machined
- Hole type in which tapping is to be done
Use above chart for tap selection
(For Ex. :- For Short chipping brass)
Select the hole type as given below
(For Ex. :- Blind hole)
Use above chart for tap selection
(For Ex. :- For short chipping brass)
Select the hole type as given below
(For Ex. :- blind hole)
- Thread depth to be produced
Select the hole type as given below
(For Ex. :- blind hole with $L > 1.5 D < 3 D$)
- Thread type required
(For Ex. :- "M" metric type of thread)
- General Tap dimensions required
(For Ex.:- IS 6175-III)
- For Thread Forming Tap :
(a) For Fig. T1 & B1- Use Fluteless Tap
(For Ex.:- $L < \text{or} = 1.5 D$)
(b) For Fig. T2 & B2 - Use Fluteless Oil Groove
(For Ex.:- $L < 3D$)
- For Blind Hole Tapping :
(a) For Fig. B1- Use 15° Spiral Flute
(For Ex.:- $L < \text{or} = 1.5 D$)
(b) For Fig. B2-Use 35° Spiral Flute
(For Ex.:- $L > 1.5 D < 3 D$)



PRODUCT RANGE

MC

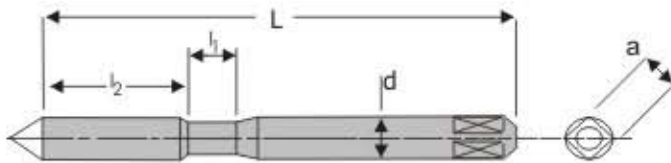

STRAIGHT FLUTE SPIRAL POINT CAST IRON SPIRAL FLUTE 15° SPIRAL FLUTE 35° FLUTELESS FLUTELESS OIL GROOVE



IS 6175 I & ISO 529

Standard Tap - HSS		✓	✓		✓	✓		
High Performance Tap - HSS-E		✓	✓	✓	✓	✓	✓	✓
Type of Hole	Through Hole	✓	✓	✓			✓	✓
	Blind Hole	✓		✓	✓	✓	✓	✓

SIZE	PITCH	L	l ₁	l ₂	d		Number of Flutes					No. of Lobes	
M1.6	0.35	41.0	5.0	8.0	2.50	2.00	3	2	3	3	3	4	4
M1.8	0.35	41.0	5.0	8.0	2.50	2.00	3	2	3	3	3	4	4
M2	0.40	41.0	5.5	8.0	2.50	2.00	3	2	3	3	3	4	4
M2.2	0.45	44.5	6.0	9.5	2.80	2.24	3	2	3	3	3	4	4
M2.5	0.45	44.5	6.0	9.5	2.80	2.24	3	2	3	3	3	4	4

IS 6175 II & ISO 529

SIZE	PITCH	L	l ₁	l ₂	d		Number of Flutes					No. of Lobes	
M3	0.50	48.0	7.0	11.0	3.15	2.50	3	3	3	3	3	4	4
M3.5	0.60	50.0	7.0	13.0	3.55	2.80	3	3	4	3	3	4	4
M4	0.70	53.0	8.0	13.0	4.00	3.15	3	3	4	3	3	4	4
M4.5	0.75	53.0	8.0	13.0	4.50	3.55	3	3	4	3	3	4	4
M5	0.80	58.0	9.0	16.0	5.00	4.00	3	3	4	3	3	4	4
M6	1.00	66.0	11.0	19.0	6.30	5.00	3	3	4	3	3	4	4
M7	1.00	66.0	11.0	19.0	7.10	5.60	3	3	4	3	3	4	4
M8	1.25	72.0	13.0	22.0	8.00	6.30	3	3	4	3	3	5	5
M9	1.25	72.0	14.0	22.0	9.00	7.10	3	3	4	3	3	5	5
M10	1.50	80.0	15.0	24.0	10.00	8.00	3	3	4	3	3	5	5

✓ : Indicates availability in 6H & 6G Tolerance class in ready stock.

MC

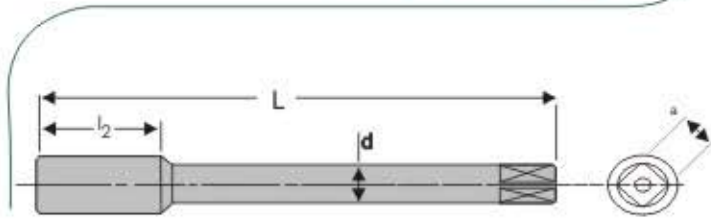

IS 6175 III & ISO 529

Standard Tap - HSS		✓	✓		✓	✓		
High Performance Tap - HSS-E		✓	✓	✓	✓	✓	✓	✓
Type of Hole	Through Hole	✓	✓	✓			✓	✓
	Blind Hole	✓		✓	✓	✓	✓	✓

SIZE	PITCH	L	l ₂	d		Number of Flutes					No. of Lobes	
M3	0.50	48.0	11.0	2.24	1.80	3	3	3	3	3	4	4
M3.5	0.60	50.0	13.0	2.50	2.00	3	3	4	3	3	4	4
M4	0.70	53.0	13.0	3.15	2.50	3	3	4	3	3	4	4
M4.5	0.75	53.0	13.0	3.55	2.80	3	3	4	3	3	4	4
M5	0.80	58.0	16.0	4.00	3.15	3	3	4	3	3	4	4
M6	1.00	66.0	19.0	4.50	3.55	3	3	4	3	3	4	4
M7	1.00	66.0	19.0	5.60	4.50	3	3	4	3	3	4	4
M8	1.25	72.0	22.0	6.30	5.00	3	3	4	3	3	5	5
M9	1.25	72.0	22.0	7.10	5.60	3	3	4	3	3	5	5
M10	1.50	80.0	24.0	8.00	6.30	3	3	4	3	3	5	5
M11	1.50	85.0	25.0	8.00	6.30	3	3	4	3	3	5	5
M12	1.75	89.0	29.0	9.00	7.10	4	3	4	3	3	5	5
M14	2.00	95.0	30.0	11.20	9.00	4	3	4	3	3	6	6
M16	2.00	102.0	32.0	12.50	10.00	4	3	4	3	3	6	6
M18	2.50	112.0	37.0	14.00	11.20	4	4	4	4	4	8	8
M20	2.50	112.0	37.0	14.00	11.20	4	4	4	4	4	8	8
M22	2.50	118.0	38.0	16.00	12.50	4	4	4	4	4	8	8
M24	3.00	130.0	45.0	18.00	14.00	4	4	4	4	4	8	8
M27	3.00	135.0	45.0	20.00	16.00	4	4	4	4	4	8	8
M30	3.50	138.0	48.0	20.00	16.00	4	4	4	4	4	8	8
M33	3.50	151.0	51.0	22.40	18.00	4	6	4	4	4	-	-
M36	4.00	162.0	57.0	25.00	20.00	4	6	4	4	4	-	-
M39	4.00	170.0	60.0	28.00	22.40	4	6	4	4	4	-	-
M42	4.50	170.0	60.0	28.00	22.40	6	6	6	6	6	-	-
M45	4.50	187.0	67.0	31.50	25.00	6	6	6	6	6	-	-
M48	5.00	187.0	67.0	31.50	25.00	6	6	6	6	6	-	-

✓ : Indicates availability in 6H & 6G Tolerance class in ready stock.

MC

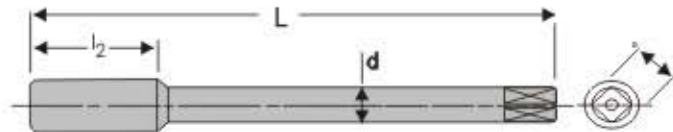

IS 6175 IV & ISO 2283

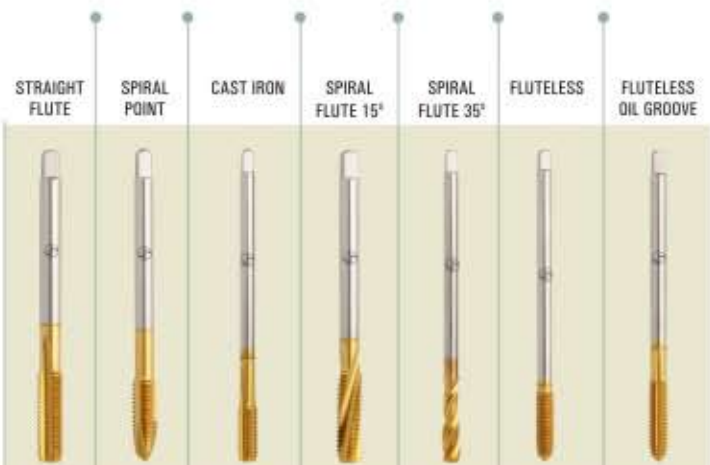

Standard Tap - HSS		✓	✓		✓	✓		
High Performance Tap - HSS-E		✓	✓	✓	✓	✓	✓	✓
Type of Hole	Through Hole	✓	✓	✓			✓	✓
	Blind Hole	✓		✓	✓	✓	✓	✓

SIZE	PITCH	L	l ₂	d		Number of Flutes					No. of Lobes	
						1	2	3	4	5	6	7
M3	0.50	66.0	11.0	2.24	1.80	3	3	3	3	3	4	4
M3.5	0.60	68.0	13.0	2.50	2.00	3	3	4	3	3	4	4
M4	0.70	73.0	13.0	3.15	2.50	3	3	4	3	3	4	4
M4.5	0.75	73.0	13.0	3.55	2.80	3	3	4	3	3	4	4
M5	0.80	79.0	16.0	4.00	3.15	3	3	4	3	3	4	4
M6	1.00	89.0	19.0	4.50	3.55	3	3	4	3	3	4	4
M7	1.00	89.0	19.0	5.60	4.50	3	3	4	3	3	4	4
M8	1.25	97.0	22.0	6.30	5.00	3	3	4	3	3	5	5
M9	1.25	97.0	22.0	7.10	5.60	3	3	4	3	3	5	5
M10	1.50	108.0	24.0	8.00	6.30	3	3	4	3	3	5	5
M11	1.50	115.0	25.0	8.00	6.30	3	3	4	3	3	5	5
M12	1.75	119.0	29.0	9.00	7.10	4	3	4	3	3	5	5
M14	2.00	127.0	30.0	11.20	9.00	4	3	4	3	3	6	6
M16	2.00	137.0	32.0	12.50	10.00	4	3	4	3	3	6	6
M18	2.50	149.0	37.0	14.00	11.20	4	4	4	4	4	8	8
M20	2.50	149.0	37.0	14.00	11.20	4	4	4	4	4	8	8
M22	2.50	158.0	38.0	16.00	12.50	4	4	4	4	4	8	8
M24	3.00	172.0	45.0	18.00	14.00	4	4	4	4	4	8	8

Note :-In 35° spiral fluted tap, thread Length (l₂) is shorter than thread length in other types of tap

✓ : Indicates availability in 6H & 6G Tolerance class in ready stock.

MC

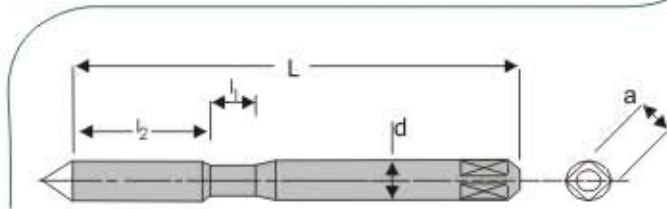

DIN 371

High Performance Tap - HSS-E

Type of Hole

Through Hole

Blind Hole

STRAIGHT FLUTE SPIRAL POINT CAST IRON SPIRAL FLUTE 15° SPIRAL FLUTE 35° FLUTELESS FLUTELESS OIL GROOVE



✓	✓	✓	✓	✓	✓	✓
✓	✓	✓			✓	✓
✓		✓	✓	✓	✓	✓

SIZE	PITCH	L	l ₁	l ₂	d		Number of Flutes					No. of Lobes	
M1.6	0.35	41.0	5.0	8.0	2.50	2.00	3	2	3	3	3	4	4
M2	0.40	45.0	1.0	8.0	2.8	2.1	3	2	3	3	3	4	4
M2.5	0.45	50.0	1.0	9.0	2.8	2.1	3	2	3	3	3	4	4
M3	0.50	56.0	7.0	11.0	3.5	2.7	3	3	3	3	3	4	4
M3.5	0.60	56.0	7.0	13.0	4.0	3.0	3	3	4	3	3	4	4
M4	0.70	63.0	8.0	13.0	4.5	3.4	3	3	4	3	3	4	4
M5	0.80	70.0	9.0	16.0	6.0	4.9	3	3	4	3	3	4	4
M6	1.00	80.0	11.0	19.0	6.0	4.9	3	3	4	3	3	4	4
M7	1.00	80.0	11.0	19.0	7.0	5.5	3	3	4	3	3	4	4
M8	1.25	90.0	13.0	22.0	8.0	6.2	3	3	4	3	3	5	5
M10	1.50	100.0	15.0	24.0	10.0	8.0	3	3	4	3	3	5	5

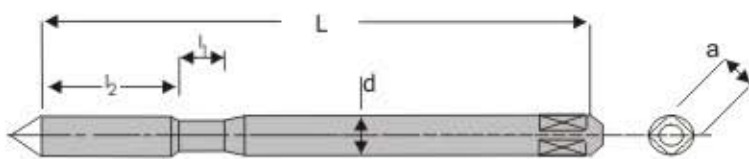

DIN 371 EXTRA LONG TAP

100 mm long :- in M3 to M8
 120 mm long :- in M4 to M12
 150 mm long :- in M5 to M12



✓ : Indicates availability in 6H & 6G Tolerance class in ready stock.

MC

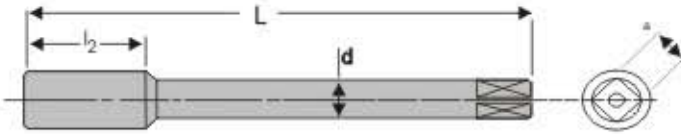

DIN 376

High Performance Tap - HSS-E (Coating Available)

Type of Hole

Through Hole

Blind Hole

STRAIGHT FLUTE	SPIRAL POINT	CAST IRON	SPIRAL FLUTE 15°	SPIRAL FLUTE 35°	FLUTELESS	FLUTELESS OIL GROOVE
✓	✓	✓	✓	✓	✓	✓
✓	✓	✓			✓	✓
✓		✓	✓	✓	✓	✓

SIZE	PITCH	L	l ₂	d		Number of Flutes					No. of Lobes	
M3	0.50	56.0	11.0	2.2		3	3	3	3	3	4	4
M4	0.70	63.0	13.0	2.8	2.1	3	3	4	3	3	4	4
M5	0.80	70.0	16.0	3.5	2.7	3	3	4	3	3	4	4
M6	1.00	80.0	19.0	4.5	3.4	3	3	4	3	3	4	4
M8	1.25	90.0	22.0	6.0	4.9	3	3	4	3	3	5	5
M10	1.50	100.0	24.0	7.0	5.5	3	3	4	3	3	5	5
M12	1.75	110.0	29.0	9.0	7.0	3	3	4	3	3	5	5
M14	2.00	110.0	30.0	11.0	9.0	3	3	4	3	3	6	6
M16	2.00	110.0	32.0	12.0	9.0	3	3	4	3	3	6	6

✓ : Indicates availability in 6H & 6G Tolerance class in ready stock.

MF

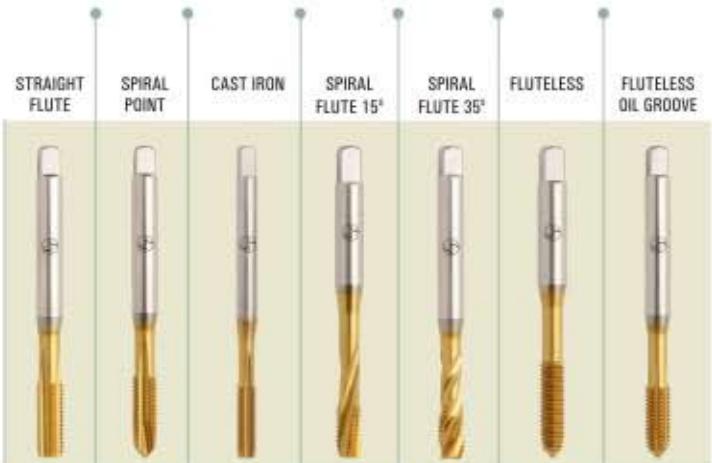
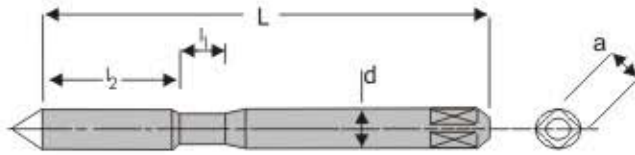

IS 6175 I & ISO 529

Standard Tap - HSS	✓	✓		✓	✓		
High Performance Tap - HSS-E	✓	✓	✓	✓	✓	✓	✓
Type of Hole	Through Hole	✓	✓	✓		✓	✓
	Blind Hole	✓		✓	✓	✓	✓

SIZE	PITCH	L	l ₁	l ₂	d		Number of Flutes					No. of Lobes	
M2.5	0.35	44.5	6.0	9.5	2.8	2.24	3	2	3	3	3	4	4

IS 6175 II & ISO 529

SIZE	PITCH	L	l ₁	l ₂	d		Number of Flutes					No. of Lobes	
M3	0.35	48.0	7.0	11.0	3.15	2.50	3	3	3	3	3	4	4
M3.5	0.35	50.0	7.0	13.0	3.55	2.80	3	3	4	3	3	4	4
M4	0.50	53.0	8.0	13.0	4.00	3.15	3	3	4	3	3	4	4
M4.5	0.50	53.0	8.0	13.0	4.50	3.55	3	3	4	3	3	4	4
M5	0.50	58.0	9.0	16.0	5.00	4.00	3	3	4	3	3	4	4
M5.5	0.50	62.0	9.0	17.0	5.60	4.50	3	3	4	3	3	4	4
M6	0.75	66.0	11.0	19.0	6.30	5.00	3	3	4	3	3	4	4
M7	0.75	66.0	11.0	19.0	7.10	5.60	3	3	4	3	3	4	4
M8	0.75	66.0	13.0	16.0	8.00	6.30	3	3	4	3	3	5	5
M8	1.00	69.0	13.0	19.0	8.00	6.30	3	3	4	3	3	5	5
M9	0.75	66.0	14.0	16.0	9.00	7.10	3	3	4	3	3	5	5
M9	1.00	69.0	14.0	19.0	9.00	7.10	3	3	4	3	3	5	5
M10	0.75	73.0	15.0	17.0	10.00	8.00	3	3	4	3	3	5	5
M10	1.00	76.0	15.0	20.0	10.00	8.00	3	3	4	3	3	5	5
M10	1.25	76.0	15.0	20.0	10.00	8.00	3	3	4	3	3	5	5

✓ : Indicates availability in 6H Tolerance class in ready stock.

MF

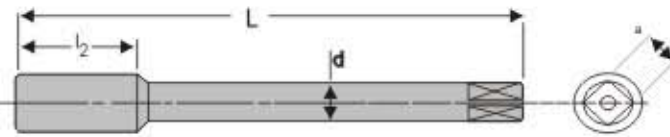

	STRAIGHT FLUTE	SPIRAL POINT	CAST IRON	SPIRAL FLUTE 15°	SPIRAL FLUTE 35°	FLUTELESS	FLUTELESS OIL GROOVE
Standard Tap - HSS	✓	✓		✓	✓		
High Performance Tap - HSS-E	✓	✓	✓	✓	✓	✓	✓
Type of Hole	Through Hole	✓	✓			✓	✓
	Blind Hole	✓		✓	✓	✓	✓

IS 6175 III & ISO 529

SIZE	PITCH	L	l_2	d		Number of Flutes					No. of Lobes	
M3	0.35	48.0	11.0	2.24	1.80	3	3	3	3	3	4	4
M3.5	0.35	50.0	13.0	2.50	2.00	3	3	4	3	3	4	4
M4	0.50	53.0	13.0	3.15	2.50	3	3	4	3	3	4	4
M4.5	0.50	53.0	13.0	3.55	2.80	3	3	4	3	3	4	4
M5	0.50	58.0	16.0	4.00	3.15	3	3	4	3	3	4	4
M5.5	0.50	62.0	17.0	4.00	3.15	3	3	4	3	3	4	4
M6	0.75	66.0	19.0	4.50	3.55	3	3	4	3	3	4	4
M7	0.75	66.0	19.0	5.60	4.50	3	3	4	3	3	4	4
M8	0.75	66.0	16.0	6.30	5.00	3	3	4	3	3	4	4
M8	1.00	69.0	19.0	6.30	5.00	3	3	4	3	3	5	5
M9	0.75	66.0	16.0	7.10	5.60	3	3	4	3	3	5	5
M9	1.00	69.0	19.0	7.10	5.60	3	3	4	3	3	5	5
M10	0.75	73.0	17.0	8.00	6.30	3	3	4	3	3	5	5
M10	1.00	76.0	20.0	8.00	6.30	3	3	4	3	3	5	5
M10	1.25	76.0	20.0	8.00	6.30	3	3	4	3	3	5	5
M11	0.75	80.0	20.0	8.00	6.30	3	3	4	3	3	5	5
M11	1.00	80.0	20.0	8.00	6.30	3	3	4	3	3	5	5
M12	1.00	80.0	20.0	9.00	7.10	4	3	4	3	3	5	5
M12	1.25	84.0	24.0	9.00	7.10	4	3	4	3	3	5	5
M12	1.50	89.0	29.0	9.00	7.10	4	3	4	3	3	5	5
M14	1.00	87.0	22.0	11.20	9.00	4	3	4	3	3	6	6
M14	1.25	90.0	25.0	11.20	9.00	4	3	4	3	3	6	6
M14	1.50	95.0	30.0	11.20	9.00	4	3	4	3	3	6	6
M15	1.00	87.0	22.0	11.20	9.00	4	3	4	3	3	6	6
M15	1.50	95.0	30.0	11.20	9.00	4	3	4	3	3	6	6
M16	1.00	92.0	22.0	12.50	10.00	4	3	4	3	3	6	6
M16	1.50	102.0	32.0	12.50	10.00	4	3	4	3	3	6	6
M17	1.00	92.0	22.0	12.50	10.00	4	3	4	3	3	6	6
M17	1.50	102.0	32.0	12.50	10.00	4	3	4	3	3	6	6
M18	1.00	97.0	22.0	14.00	11.20	4	4	4	4	4	8	8
M18	1.50	104.0	29.0	14.00	11.20	4	4	4	4	4	8	8
M18	2.00	112.0	37.0	14.00	11.20	4	4	4	4	4	8	8
M20	1.00	102.0	27.0	14.00	11.20	4	4	4	4	4	8	8
M20	1.50	104.0	29.0	14.00	11.20	4	4	4	4	4	8	8

Note :-In 35° spiral fluted tap, thread Length (l_2) is shorter than thread length in other types of tap

✓ : Indicates availability in 6H Tolerance class in ready stock.

MF

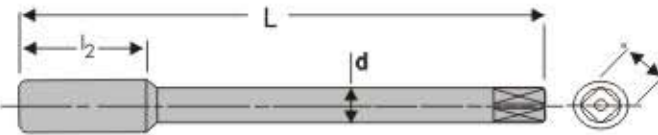

	STRAIGHT FLUTE	SPIRAL POINT	CAST IRON	SPIRAL FLUTE 15°	SPIRAL FLUTE 35°	FLUTELESS	FLUTELESS OIL GROOVE
Standard Tap - HSS	✓	✓		✓	✓		
High Performance Tap - HSS-E	✓	✓	✓	✓	✓	✓	✓
Type of Hole	Through Hole	✓	✓			✓	✓
	Blind Hole	✓		✓	✓	✓	✓

IS 6175 IV & ISO 2283

	STRAIGHT FLUTE	SPIRAL POINT	CAST IRON	SPIRAL FLUTE 15°	SPIRAL FLUTE 35°	FLUTELESS	FLUTELESS OIL GROOVE
Standard Tap - HSS	✓	✓		✓	✓		
High Performance Tap - HSS-E	✓	✓	✓	✓	✓	✓	✓
Type of Hole	Through Hole	✓	✓			✓	✓
	Blind Hole	✓		✓	✓	✓	✓

SIZE	PITCH	L	l_2	d	$\frac{a}{d}$	Number of Flutes					No. of Lobes	
M3	0.35	66.0	11.0	2.24	1.80	3	3	3	3	3	4	4
M3.5	0.35	68.0	13.0	2.50	2.00	3	3	4	3	3	4	4
M4	0.50	73.0	13.0	3.15	2.50	3	3	4	3	3	4	4
M4.5	0.50	73.0	13.0	3.55	2.80	3	3	4	3	3	4	4
M5	0.50	79.0	16.0	4.00	3.15	3	3	4	3	3	4	4
M5.5	0.50	84.0	17.0	4.00	3.15	3	3	4	3	3	4	4
M6	0.75	89.0	19.0	4.50	3.55	3	3	4	3	3	4	4
M7	0.75	89.0	19.0	5.60	4.50	3	3	4	3	3	4	4
M8	0.75	91.0	16.0	6.30	5.00	3	3	4	3	3	5	5
M8	1.00	97.0	19.0	6.30	5.00	3	3	4	3	3	5	5
M9	0.75	94.0	16.0	7.10	5.60	3	3	4	3	3	5	5
M9	1.00	97.0	19.0	7.10	5.60	3	3	4	3	3	5	5
M10	0.75	104.0	17.0	8.00	6.30	3	3	4	3	3	5	5
M10	1.00	108.0	20.0	8.00	6.30	3	3	4	3	3	5	5
M10	1.25	108.0	20.0	8.00	6.30	3	3	4	3	3	5	5
M11	0.75	110.0	20.0	8.00	6.30	3	3	4	3	3	5	5
M11	1.00	110.0	20.0	8.00	6.30	3	3	4	3	3	5	5
M12	1.00	110.0	20.0	9.00	7.10	4	3	4	3	3	5	5
M12	1.25	119.0	24.0	9.00	7.10	4	3	4	3	3	5	5
M12	1.50	119.0	29.0	9.00	7.10	4	3	4	3	3	5	5
M14	1.00	124.0	22.0	11.20	9.00	4	3	4	3	3	6	6
M14	1.25	127.0	25.0	11.20	9.00	4	3	4	3	3	6	6
M14	1.50	127.0	30.0	11.20	9.00	4	3	4	3	3	6	6
M15	1.00	124.0	22.0	11.20	9.00	4	3	4	3	3	6	6
M15	1.50	127.0	30.0	11.20	9.00	4	3	4	3	3	6	6
M16	1.00	127.0	22.0	12.50	10.00	4	3	4	3	3	6	6
M16	1.50	137.0	32.0	12.50	10.00	4	3	4	3	3	6	6
M17	1.00	127.0	22.0	12.50	10.00	4	3	4	3	3	6	6
M17	1.50	137.0	32.0	12.50	10.00	4	3	4	3	3	6	6
M18	1.00	135.0	22.0	14.00	11.20	4	4	4	4	4	8	8
M18	1.50	142.0	29.0	14.00	11.20	4	4	4	4	4	8	8
M18	2.00	149.0	37.0	14.00	11.20	4	4	4	4	4	8	8
M20	1.00	140.0	27.0	14.00	11.20	4	4	4	4	4	8	8
M20	1.50	142.0	29.0	14.00	11.20	4	4	4	4	4	8	8
M20	2.00	149.0	37.0	14.00	11.20	4	4	4	4	4	8	8
M22	1.00	149.0	29.0	16.00	12.50	4	4	4	4	4	8	8
M22	1.50	153.0	33.0	16.00	12.50	4	4	4	4	4	8	8
M22	2.00	158.0	38.0	16.00	12.50	4	4	4	4	4	8	8
M24	1.50	172.0	35.0	18.00	14.00	4	4	4	4	4	8	8
M24	2.00	172.0	35.0	18.00	14.00	4	4	4	4	4	8	8

Note :- In 35° spiral fluted tap, thread Length (l_2) is shorter than thread length in other types of tap
 ✓ : Indicates availability in 6H Tolerance class in ready stock.

MF

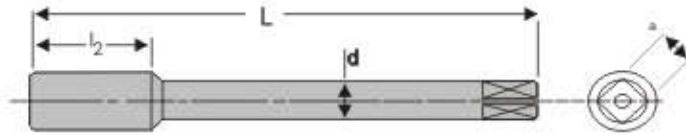

STRAIGHT FLUTE SPIRAL POINT CAST IRON SPIRAL FLUTE 15° SPIRAL FLUTE 35° FLUTELESS FLUTELESS OIL GROOVE



DIN 374

Standard Tap - HSS

High Performance Tap - HSS-E

Type of Hole	Through Hole	✓	✓	✓	✓	✓	✓	✓	✓	✓	✓	✓
	Blind Hole	✓		✓	✓	✓	✓	✓	✓	✓	✓	✓

SIZE	PITCH	L	l ₂	d		Number of Flutes					No. of Lobes	
M3	0.35	56.0	9.0	2.2		3	3	3	3	3	4	4
M3.5	0.35	56.0	10.0	2.5	2.10	3	3	4	3	3	4	4
M4	0.35	63.0	10.0	2.8	2.10	3	3	4	3	3	4	4
M4	0.50	63.0	10.0	2.8	2.10	3	3	4	3	3	4	4
M4.5	0.50	70.0	12.0	3.5	2.70	3	3	4	3	3	4	4
M5	0.50	70.0	12.0	3.5	2.70	3	3	4	3	3	4	4
M5	0.75	70.0	12.0	3.5	2.70	3	3	4	3	3	4	4
M5.5	0.50	80.0	12.0	4.0	3.00	3	3	4	3	3	4	4
M6	0.50	80.0	14.0	4.5	3.40	3	3	4	3	3	4	4
M6	0.75	80.0	14.0	4.5	3.40	3	3	4	3	3	4	4
M7	0.75	80.0	14.0	5.5	4.30	3	3	4	3	3	4	4
M8	0.50	80.0	19.0	6.0	4.90	3	3	4	3	3	5	5
M8	0.75	80.0	19.0	6.0	4.90	3	3	4	3	3	5	5
M8	1.00	90.0	22.0	6.0	4.90	3	3	4	3	3	5	5
M9	0.75	80.0	19.0	7.0	5.50	3	3	4	3	3	5	5
M9	1.00	90.0	22.0	7.0	5.50	3	3	4	3	3	5	5
M10	0.75	90.0	20.0	7.0	5.50	3	3	4	3	3	5	5
M10	1.00	90.0	20.0	7.0	5.50	3	3	4	3	3	5	5
M10	1.25	100.0	24.0	7.0	5.50	3	3	4	3	3	5	5
M11	0.75	90.0	20.0	8.0	6.20	3	3	4	3	3	5	5
M11	1.00	90.0	20.0	8.0	6.20	3	3	4	3	3	5	5
M11	1.25	90.0	22.0	8.0	6.20	3	3	4	3	3	5	5
M12	0.75	100.0	22.0	9.0	7.00	3	3	4	3	3	5	5
M12	1.00	100.0	22.0	9.0	7.00	3	3	4	3	3	5	5
M12	1.25	100.0	22.0	9.0	7.00	3	3	4	3	3	5	5
M13	1.00	100.0	22.0	11.0	9.00	3	3	4	3	3	6	6
M13	1.50	100.0	22.0	11.0	9.00	3	3	4	3	3	6	6
M14	0.75	100.0	22.0	11.0	9.00	3	3	4	3	3	6	6
M14	1.00	100.0	22.0	11.0	9.00	3	3	4	3	3	6	6
M14	1.25	100.0	22.0	11.0	9.00	3	3	4	3	3	6	6
M14	1.50	100.0	22.0	11.0	9.00	3	3	4	3	3	6	6
M15	1.00	100.0	22.0	12.0	9.00	3	3	4	3	3	6	6
M15	1.50	100.0	22.0	12.0	9.00	3	3	4	3	3	6	6
M16	1.00	100.0	22.0	12.0	9.00	3	3	4	3	3	6	6
M16	1.25	100.0	22.0	12.0	9.00	3	3	4	3	3	6	6
M16	1.50		100.0		22.00	12.0	9.00	3	3	4	3	366

✓ : Indicates availability in 6H Tolerance class in ready stock.

UNC

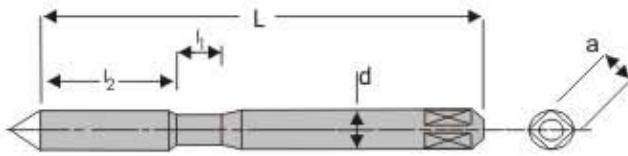

IS 6175 I, BS-949 & ISO 529

Standard Tap - HSS							✓	✓		✓	✓		
High Performance Tap - HSS-E							✓	✓	✓	✓	✓	✓	✓
Type of Hole		Through Hole					✓	✓	✓			✓	✓
		Blind Hole					✓		✓	✓	✓	✓	✓
SIZE	TPI	L	l_1	l_2	d		Number of Flutes					No. of Lobes	
NO.1	64	41.0	5.5	8.0	2.5	2.00	3	2	3	3	3	3	4
NO.2	56	44.5	6.0	9.5	2.8	2.24	3	2	3	3	3	3	4

IS 6175 II, BS-949 & ISO 529

SIZE	TPI	L	l_1	l_2	d		Number of Flutes					No. of Lobes	
NO.3	48	44.5	6.0	9.5	2.80	2.24	3	2	3	3	3	3	4
NO.4	40	48.0	7.0	11.0	3.15	2.50	3	3	3	3	3	3	4
NO.5	40	48.0	7.0	11.0	3.15	2.50	3	3	3	3	3	3	4
NO.6	32	50.0	7.0	13.0	3.55	2.80	3	3	4	3	3	3	4
NO.8	32	53.0	8.0	13.0	4.50	3.55	3	3	4	3	3	3	4
NO.10	24	58.0	9.0	16.0	5.00	4.00	3	3	4	3	3	3	4
NO.12	24	62.0	9.0	17.0	5.60	4.50	3	3	4	3	3	3	4
1/4"	20	66.0	11.0	19.0	6.30	5.00	3	3	4	3	3	3	4
5/16"	18	72.0	13.0	22.0	8.00	6.30	3	3	4	3	3	3	5
3/8"	16	80.0	15.0	24.0	10.00	8.00	3	3	4	3	3	3	5

✓ : Indicates availability in 2B Tolerance class in ready stock.

UNC

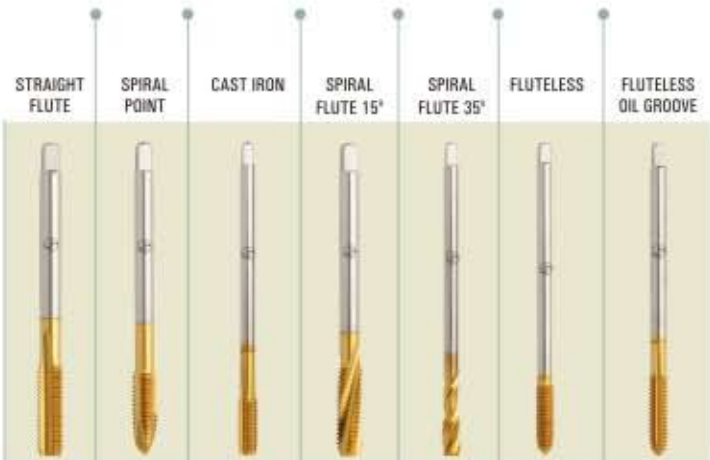
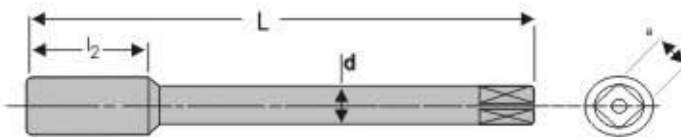

IS 6175 III, BS-949 & ISO 529

Standard Tap - HSS	✓	✓		✓	✓		
High Performance Tap - HSS-E	✓	✓	✓	✓	✓	✓	✓
Type of Hole	Through Hole	✓	✓	✓		✓	✓
	Blind Hole	✓		✓	✓	✓	✓

SIZE	TPI	L	l ₂	d		Number of Flutes					No. of Lobes	
7/16"	14	85.0	25.0	8.0	6.30	4	3	4	3	3	5	5
1/2"	13	89.0	29.0	9.0	7.10	4	3	4	3	3	5	5
9/16"	12	95.0	30.0	11.2	9.00	4	3	4	3	3	6	6
5/8"	11	102.0	32.0	12.5	10.00	4	3	4	3	3	6	6
3/4"	10	112.0	37.0	14.0	11.20	4	3	4	3	3	8	8
7/8"	9	118.0	38.0	16.0	12.50	4	4	4	4	4	8	8
1"	8	130.0	45.0	18.0	14.00	4	4	4	4	4	8	8
1.1/8"	7	138.0	48.0	20.0	16.00	4	4	6	4	4	-	-
1.1/4"	7	151.0	51.0	22.4	18.00	4	4	6	4	4	-	-
1.3/8"	6	162.0	57.0	25.0	20.00	6	4	6	4	4	-	-
1.1/2"	6	170.0	60.0	28.0	22.40	6	4	6	4	4	-	-
1.3/4"	5	187.0	67.0	31.5	25.00	6	6	6	6	6	-	-
2"	4.5	200.0	70.0	35.5	28.00	6	6	6	6	6	-	-

IS 6175 IV, BS-949 & ISO 2283

SIZE	TPI	L	l ₂	d		Number of Flutes					No. of Lobes	
No.5	40	66.0	11.0	2.24	1.80	3	3	3	3	3	4	4
No.6	32	68.0	13.0	2.50	2.00	3	3	4	3	3	4	4
No.8	32	73.0	13.0	3.15	2.50	3	3	4	3	3	4	4
No.10	24	79.0	16.0	4.00	3.15	3	3	4	3	3	4	4
1/4"	20	89.0	19.0	4.50	3.55	3	3	4	3	3	4	4
5/16"	18	97.0	22.0	6.30	5.00	3	3	4	3	3	5	5
3/8"	16	108.0	24.0	8.00	6.30	3	3	4	3	3	5	5
7/16"	14	115.0	25.0	8.00	6.30	4	3	4	3	3	5	5
1/2"	13	119.0	29.0	9.00	7.10	4	3	4	3	3	5	5
9/16"	12	127.0	30.0	11.20	9.00	4	3	4	3	3	6	6
5/8"	11	137.0	32.0	12.50	10.00	4	3	4	3	3	6	6
3/4"	10	149.0	37.0	14.00	11.20	4	3	4	3	3	6	6

✓ : Indicates availability in 2B Tolerance class in ready stock.

UNC

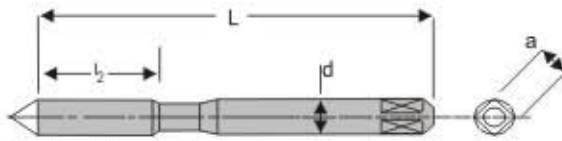

DIN 371

High Performance Tap - HSS-E

Type of Hole

Through Hole

Blind Hole

STRAIGHT FLUTE SPIRAL POINT CAST IRON SPIRAL FLUTE 15° SPIRAL FLUTE 35° FLUTELESS FLUTELESS OIL GROOVE



✓	✓	✓	✓	✓	✓	✓
✓	✓	✓			✓	✓
✓		✓	✓	✓	✓	✓

SIZE	TPI	L	l ₂	d		Number of Flutes					No. of Lobes	
NO.4	40	50.0	10.0	3.5	2.7	3	3	3	3	3	4	4
NO.5	40	56.0	11.0	3.5	2.7	3	3	3	3	3	4	4
NO.6	32	56.0	12.0	4.0	3.0	3	3	4	3	3	4	4
NO.8	32	63.0	13.0	4.5	3.4	3	3	4	3	3	4	4
NO.10	24	70.0	15.0	6.0	4.9	3	3	4	3	3	4	4
NO.12	24	70.0	16.0	6.0	4.9	3	3	4	3	3	4	4
1/4"	20	80.0	17.0	7.0	5.5	3	3	4	3	3	4	4
5/16"	18	90.0	20.0	8.0	6.2	3	3	4	3	3	5	5
3/8"	16	100.0	22.0	9.0	7.0	3	3	4	3	3	5	5

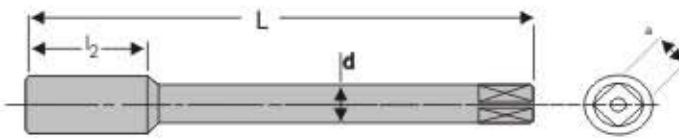

DIN 376

High Performance Tap (HSS-E) Coating Available

Type of Hole

Through Hole

Blind Hole

STRAIGHT FLUTE SPIRAL POINT CAST IRON SPIRAL FLUTE 15° SPIRAL FLUTE 35° FLUTELESS FLUTELESS OIL GROOVE



✓	✓	✓	✓	✓	✓	✓
✓	✓	✓			✓	✓
✓		✓	✓	✓	✓	✓

SIZE	TPI	L	l ₂	d		Number of Flutes					No. of Lobes	
NO.4	40	50.0	10.0	1.8		3	3	3	3	3	4	4
NO.5	40	56.0	11.0	2.2	1.80	3	3	3	3	3	4	4
NO.6	32	56.0	12.0	2.5	2.10	3	3	4	3	3	4	4
NO.8	32	63.0	13.0	2.8	2.10	3	3	4	3	3	4	4
NO.10	24	70.0	15.0	3.5	2.70	3	3	4	3	3	4	4
NO.12	24	70.0	16.0	3.5	2.70	3	3	4	3	3	4	4
1/4"	20	80.0	17.0	4.5	3.40	3	3	4	3	3	4	4
5/16"	18	90.0	20.0	6.0	4.90	3	3	4	3	3	5	5
3/8"	16	100.0	22.0	7.0	5.50	3	3	4	3	3	5	5
7/16"	14	100.0	22.0	8.0	6.20	3	3	4	3	3	5	5
1/2"	13	110.0	25.0	9.0	7.00	3	3	4	3	3	5	5
9/16"	12	110.0	26.0	11.0	9.00	3	3	4	3	3	6	6
5/8"	11	110.0	27.0	12.0	9.00	3	3	4	3	3	6	6
3/4"	10	125.0	30.0	14.0	11.00	4	4	4	4	4	8 or 6	8 or 6

✓ : Indicates availability in 2B Tolerance class in ready stock.

UNF

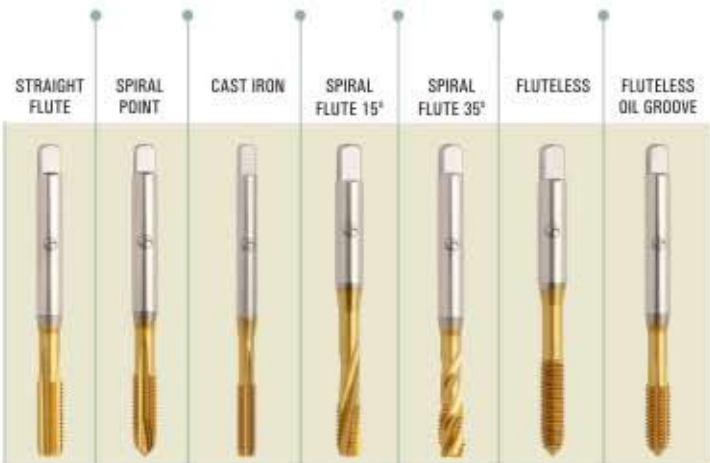
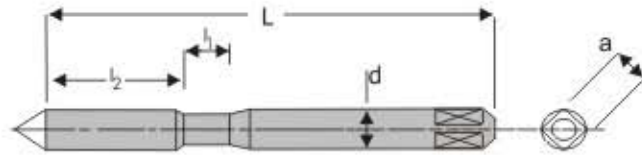

IS 6175 I, BS-949 & ISO 529

Standard Tap - HSS							✓	✓		✓	✓		
High Performance Tap - HSS-E							✓	✓	✓	✓	✓	✓	✓
Type of Hole		Through Hole					✓	✓	✓			✓	✓
		Blind Hole					✓		✓	✓	✓	✓	✓
SIZE	TPI	L	l ₁	l ₂	d		Number of Flutes					No. of Lobes	
NO.1	72	41.0	5.5	8.0	2.50	2.00	3	2	3	3	3	4	4
NO.2	64	44.5	6.0	9.5	2.8	2.24	3	2	3	3	3	4	4

IS 6175 II, BS-949 & ISO 529

SIZE	TPI	L	l ₁	l ₂	d		Number of Flutes					No. of Lobes	
NO.3	56	44.5	6.0	9.5	2.8	2.24	3	2	3	3	3	4	4
NO.4	48	48.0	7.0	11.0	3.15	2.50	3	3	3	3	3	4	4
NO.5	44	48.0	7.0	11.0	3.15	2.50	3	3	3	3	3	4	4
NO.6	40	50.0	7.0	13.0	3.55	2.80	3	3	4	3	3	4	4
NO.8	36	53.0	8.0	13.0	4.50	3.55	3	3	4	3	3	4	4
NO.10	32	58.0	9.0	16.0	5.00	4.00	3	3	4	3	3	4	4
NO.12	28	62.0	9.0	17.0	5.60	4.50	3	3	4	3	3	4	4
1/4"	28	66.0	11.0	19.0	6.30	5.00	3	3	4	3	3	4	4
5/16"	24	69.0	13.0	19.0	8.00	6.30	3	3	4	3	3	5	5
3/8"	24	76.0	15.0	20.0	10.00	8.00	3	3	4	3	3	5	5

✓ : Indicates availability in 2B Tolerance class in ready stock.

UNF

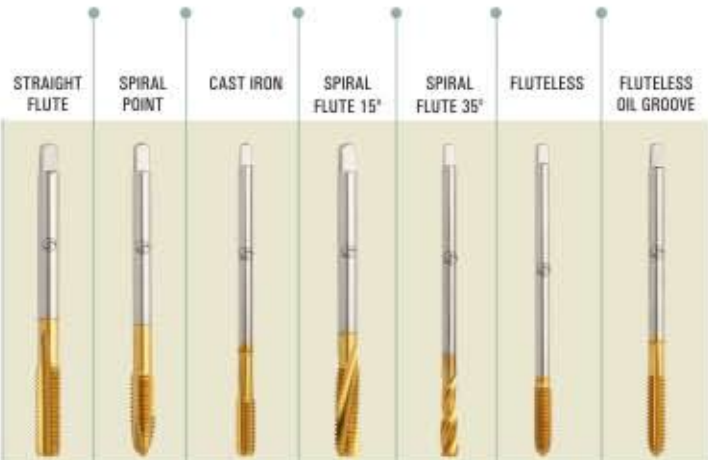
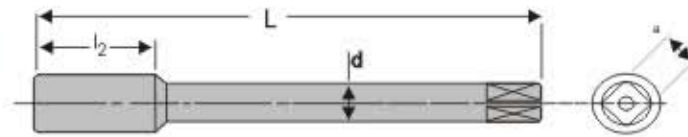

IS 6175 III, BS-949 & ISO 529

Standard Tap - HSS

High Performance Tap - HSS-E

Type of Hole	Through Hole	STRAIGHT FLUTE	SPIRAL POINT	CAST IRON	SPIRAL FLUTE 15°	SPIRAL FLUTE 35°	FLUTELESS	FLUTELESS OIL GROOVE
	Blind Hole		✓		✓	✓	✓	✓

SIZE	TPI	L	l_2	d		Number of Flutes					No. of Lobes	
7/16"	20	82.0	22.0	8.0	6.3	4	3	4	3	3	5	5
1/2"	20	84.0	24.0	9.0	7.1	4	3	4	3	3	5	5
9/16"	18	90.0	25.0	11.2	9.0	4	3	4	4	4	6	6
5/8"	18	95.0	25.0	12.5	10.0	4	3	4	4	4	6	6
3/4"	16	104.0	29.0	14.0	11.2	4	3	4	4	4	8	8
7/8"	14	113.0	33.0	16.0	12.5	4	4	4	4	4	8	8
1"	12	120.0	35.0	18.0	14.0	4	4	4	4	4	8	8
1.1/8"	12	127.0	37.0	20.0	16.0	6	4	6	4	4	-	-
1.1/4"	12	137.0	37.0	22.4	18.0	6	4	6	4	4	-	-
1.3/8"	12	144.0	39.0	25.0	20.0	6	4	6	4	4	-	-
1.1/2"	12	149.0	39.0	28.0	22.4	6	4	6	4	4	-	-

IS 6175 IV, BS-949 & ISO 2283

SIZE	TPI	L	l_2	d		Number of Flutes					No. of Lobes	
No.5	44	66	11	2.24	1.80	3	3	3	3	3	4	4
No.6	40	68	13	2.50	2.00	3	3	4	3	3	4	4
No.8	36	73	13	3.15	2.50	3	3	4	3	3	4	4
No.10	32	79	16	4.00	3.15	3	3	4	3	3	4	4
1/4"	28	89	19	4.50	3.55	3	3	4	3	3	4	4
5/16"	24	97	19	6.30	5.00	3	3	4	3	3	5	5
3/8"	24	108	20	8.00	6.30	3	3	4	3	3	5	5
7/16"	20	110	20	8.00	6.30	4	3	4	3	3	5	5
1/2"	20	119	24	9.00	7.10	4	3	4	3	3	5	5
9/16"	18	127	25	11.20	9.00	4	3	4	4	4	6	6
5/8"	18	137	32	12.50	10.00	4	3	4	4	4	6	6
3/4"	16	142	29	14.00	11.20	4	3	4	4	4	6	6
7/8"	14	153	33	16.00	12.50	4	4	4	4	4	6	6

✓ : Indicates availability in 2B Tolerance class in ready stock.

UNF

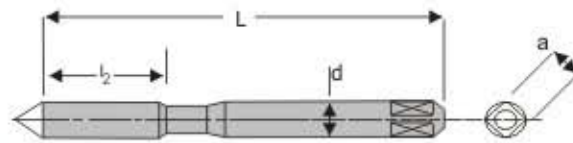

DIN 371

High Performance Tap - HSS-E

Type of Hole	Through Hole
	Blind Hole



✓	✓	✓	✓	✓	✓	✓
✓	✓	✓			✓	✓
✓		✓	✓	✓	✓	✓

SIZE	TPI	L	l ₂	d		Number of Flutes					No. of Lobes	
NO.4	48	50.0	10.0	3.5	2.7	3	3	3	3	3	4	4
NO.5	44	56.0	11.0	3.5	2.7	3	3	3	3	3	4	4
NO.6	40	56.0	12.0	4.0	3.0	3	3	4	3	3	4	4
NO.8	36	63.0	13.0	4.5	3.4	3	3	4	3	3	4	4
NO.10	32	70.0	15.0	6.0	4.9	3	3	4	3	3	4	4
NO.12	28	70.0	16.0	6.0	4.9	3	3	4	3	3	4	4
1/4"	28	80.0	17.0	7.0	5.5	3	3	4	3	3	4	4
5/16"	24	90.0	17.0	8.0	6.2	3	3	4	3	3	5	5
3/8"	24	100.0	18.0	9.0	7.0	3	3	4	3	3	5	5

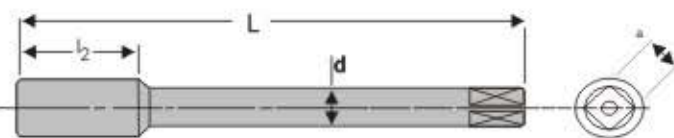

DIN 376

High Performance Tap - HSS-E (Coating Available)

Type of Hole	Through Hole
	Blind Hole



✓	✓	✓	✓	✓	✓	✓
✓	✓	✓			✓	✓
✓		✓	✓	✓	✓	✓

SIZE	TPI	L	l ₂	d		Number of Flutes					No. of Lobes	
NO.4	48	50.0	10.0	1.8		3	3	3	3	3	4	4
NO.5	44	56.0	11.0	2.2	1.80	3	3	3	3	3	4	4
NO.6	40	56.0	12.0	2.5	2.10	3	3	4	3	3	4	4
NO.8	36	63.0	13.0	2.8	2.10	3	3	4	3	3	4	4
NO.10	32	70.0	15.0	3.5	2.70	3	3	4	3	3	4	4
NO.12	28	70.0	16.0	3.5	2.70	3	3	4	3	3	4	4
1/4"	28	80.0	17.0	4.5	3.40	3	3	4	3	3	4	4
5/16"	24	90.0	17.0	6.0	4.90	3	3	4	3	3	5	5
3/8"	24	100.0	18.0	7.0	5.50	3	3	4	3	3	5	5
7/16"	20	100.0	22.0	8.0	6.20	3	3	4	3	3	5	5
1/2"	20	100.0	22.0	9.0	7.00	3	3	4	3	3	5	5
9/16"	18	100.0	22.0	11.0	9.00	3	3	4	3	3	6	6
5/8"	18	100.0	22.0	12.0	9.00	3	3	4	3	3	6	6
3/4"	16	110.0	25.0	14.0	11.00	3	4	4	4	4	8	8
7/8"	14	140.0	26.0	18.0	14.50	3	4	4	4	4	8	8
1"	12	150.0	28.0	20.0	16.00	3	4	4	4	4	8	8
1.1/4"	12	150.0	30.0	22.0	18.00	3	4	6	4	4		
1.1/2"	12	170.0	33.0	32.0	24.00	3	4	6	4	4		

✓ : Indicates availability in 2B Tolerance class in ready stock.

BSW

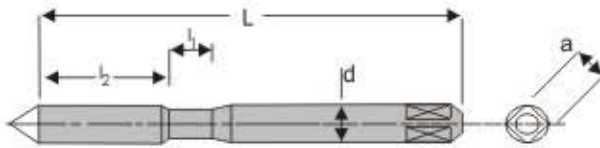

IS 6175 II, BS-949 & ISO 529



		STRAIGHT FLUTE	SPIRAL POINT	CAST IRON	SPIRAL FLUTE 15°	SPIRAL FLUTE 35°	FLUTELESS	FLUTELESS OIL GROOVE
Standard Tap - HSS		✓	✓		✓	✓		
High Performance Tap - HSS-E		✓	✓	✓	✓	✓	✓	✓
Type of Hole	Through Hole	✓	✓	✓			✓	✓
	Blind Hole	✓		✓	✓	✓	✓	✓

SIZE	TPI	L	l ₁	l ₂	d		Number of Flutes					No. of Lobes	
1/8"	40	48.0	7.0	11.0	3.15	2.5	3	3	3	3	3	3	3
5/32"	32	53.0	8.0	13.0	4.00	3.15	3	3	4	3	3	3	3
3/16"	24	58.0	9.0	16.0	5.00	4.0	3	3	4	3	3	3	3
7/32"	24	62.0	9.0	17.0	5.60	4.5	3	3	4	3	3	3	3
1/4"	20	66.0	11.0	19.0	6.30	5.0	3	3	4	3	3	3	3
9/32"	20	66.0	11.0	19.0	7.10	5.6	3	3	4	3	3	3	3
5/16"	18	72.0	13.0	22.0	8.00	6.3	3	3	4	3	3	3	3
3/8"	16	80.0	15.0	24.0	10.00	8.0	3	3	4	3	3	3	3

✓ : Indicates availability in ready stock.

BSW

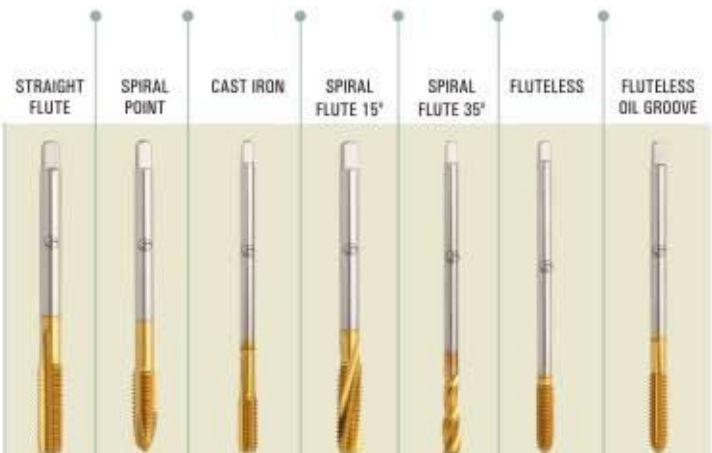
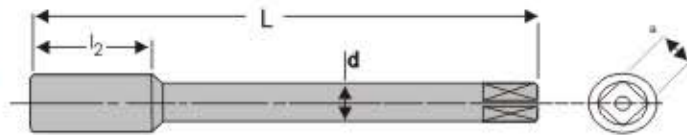

IS 6175 III, BS-949 & ISO 529

Standard Tap - HSS

High Performance Tap - HSS-E

Type of Hole	Through Hole	STRAIGHT FLUTE	SPIRAL POINT	CAST IRON	SPIRAL FLUTE 15°	SPIRAL FLUTE 35°	FLUTELESS	FLUTELESS OIL GROOVE
	Blind Hole		✓	✓	✓	✓	✓	✓

SIZE	TPI	L	l ₂	d		Number of Flutes					No. of Lobes	
						STRAIGHT FLUTE	SPIRAL POINT	CAST IRON	SPIRAL FLUTE 15°	SPIRAL FLUTE 35°	FLUTELESS	FLUTELESS OIL GROOVE
7/16"	14	85.0	25.0	8.0	6.3	4	3	4	3	3	4	4
1/2"	12	89.0	29.0	9.0	7.1	4	3	4	3	3	4	4
9/16"	12	95.0	30.0	11.2	9.0	4	3	4	3	3	4	4
5/8"	11	102.0	32.0	12.5	10.0	4	3	4	3	3	4	4
11/16"	11	112.0	37.0	14.0	11.2	4	3	4	3	3	4	4
3/4"	10	112.0	37.0	14.0	11.2	4	3	4	3	3	4	4
7/8"	9	118.0	38.0	16.0	12.5	4	4	4	4	4	4	4
1"	8	130.0	45.0	18.0	14.0	4	4	4	4	4	4	4
1.1/8"	7	138.0	48.0	20.0	16.0	4	4	6	4	4	4	4
1.1/4"	7	151.0	51.0	22.4	18.0	4	4	6	4	4	4	4
1.3/8"	6	162.0	57.0	25.0	20.0	6	4	6	4	4	6	6
1.1/2"	6	170.0	60.0	28.0	22.4	6	4	6	4	4	6	6
1.5/8"	5	170.0	60.0	28.0	22.4	6	6	6	6	6	6	6
1.3/4"	5	187.0	67.0	31.5	25.0	6	6	6	6	6	6	6
2"	4.5	200.0	70.0	35.5	28.0	6	6	6	6	6	6	6

IS 6175 IV, BS-949 & ISO 2283

SIZE	TPI	L	l ₂	d		Number of Flutes					No. of Lobes	
						STRAIGHT FLUTE	SPIRAL POINT	CAST IRON	SPIRAL FLUTE 15°	SPIRAL FLUTE 35°	FLUTELESS	FLUTELESS OIL GROOVE
3/16"	24	79	16	4.0	3.2	3	3	4	3	3	3	3
1/4"	20	89	19	4.5	3.6	3	3	4	3	3	3	3
5/16"	18	97	22	6.3	5.0	3	3	4	3	3	3	3
3/8"	16	108	24	8.0	6.3	3	3	4	3	3	3	3
7/16"	14	115	25	8.0	6.3	4	3	4	3	3	4	4
1/2"	12	119	29	9.0	7.1	4	3	4	3	3	4	4
9/16"	12	127	30	11.2	9.0	4	3	4	3	3	4	4
5/8"	11	137	32	12.5	10.0	4	3	4	3	3	4	4
11/16"	11	149	37	14.0	11.2	4	3	4	3	3	4	4
3/4"	10	149	37	14.0	11.2	4	3	4	3	3	4	4

✓ : Indicates availability in ready stock.

BSW

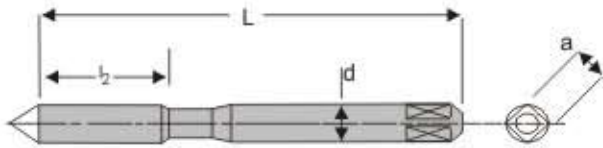

DIN 371

High Performance Tap - HSS-E

Type of Hole

Through Hole

Blind Hole

STRAIGHT FLUTE SPIRAL POINT CAST IRON SPIRAL FLUTE 15° SPIRAL FLUTE 35° FLUTELESS FLUTELESS OIL GROOVE



✓	✓	✓	✓	✓	✓	✓
✓	✓	✓			✓	✓
✓		✓	✓	✓	✓	✓

SIZE	TPI	L	l ₂	d		Number of Flutes					No. of Lobes	
1/8"	40	56.0	11.0	3.5	2.7	3	3	3	3	3	3	3
5/32"	32	63.0	13.0	4.5	3.4	3	3	4	3	3	3	3
3/16"	24	70.0	15.0	6.0	4.9	3	3	4	3	3	3	3
1/4"	20	80.0	17.0	7.0	5.5	3	3	4	3	3	3	3
5/16"	18	90.0	20.0	8.0	6.2	3	3	4	3	3	3	3
3/8"	16	100.0	22.0	9.0	7.0	3	3	4	3	3	3	3

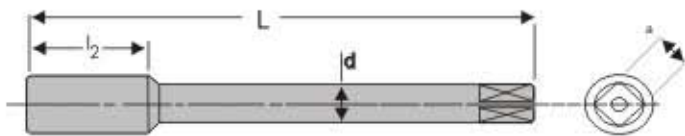

DIN 376

High Performance Tap - HSS-E

Type of Hole

Through Hole

Blind Hole

STRAIGHT FLUTE SPIRAL POINT CAST IRON SPIRAL FLUTE 15° SPIRAL FLUTE 35° FLUTELESS FLUTELESS OIL GROOVE



✓	✓	✓	✓	✓	✓	✓
✓	✓	✓			✓	✓
✓		✓	✓	✓	✓	✓

SIZE	TPI	L	l ₂	d		Number of Flutes					No. of Lobes	
1/4"	20	80.0	17.0	4.5	3.4	3	3	4	3	3	3	3
5/16"	18	90.0	20.0	6.0	4.9	3	3	4	3	3	3	3
3/8"	16	100.0	22.0	7.0	5.5	3	3	4	3	3	3	3
7/16"	14	100.0	22.0	8.0	6.2	4	3	4	3	3	4	4
1/2"	12	110.0	25.0	9.0	7.0	4	3	4	3	3	4	4
9/16"	12	110.0	26.0	11.0	9.0	4	3	4	3	3	4	4
5/8"	11	110.0	27.0	12.0	9.0	4	3	4	3	3	4	4
3/4"	10	125.0	30.0	14.0	11.0	4	3	4	3	3	4	4
7/8"	9	140.0	32.0	18.0	14.5	4	4	4	4	4	4	4
1"	8	160.0	36.0	20.0	16.0	4	4	4	4	4	4	4
1.1/4"	7	180.0	40.0	22.0	18.0	4	4	6	4	4	4	4
1.3/8"	6	200.0	50.0	28.0	22.0	4	4	6	4	4	4	4
1.1/2"	6	200.0	50.0	32.0	24.0	4	4	6	4	4	4	4

✓ : Indicates availability in ready stock.

BSSF

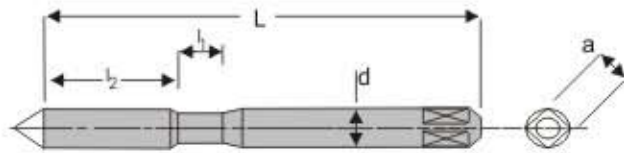

IS 6175 II, BS-949 & ISO 529

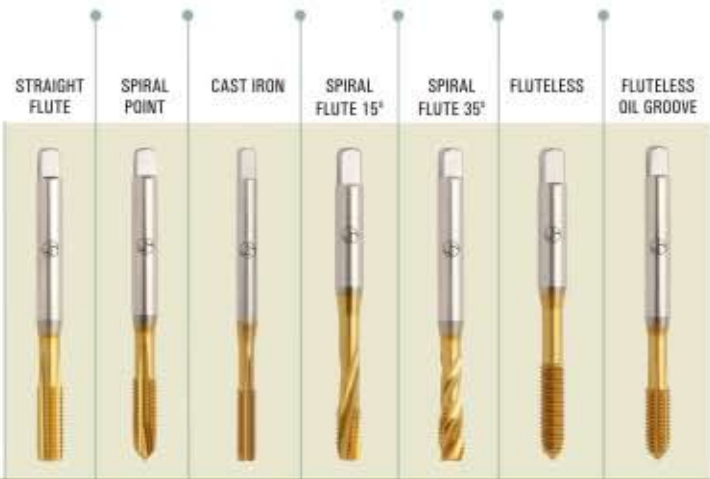

Standard Tap - HSS							✓	✓		✓	✓		
High Performance Tap - HSS-E							✓	✓	✓	✓	✓	✓	✓
Type of Hole	Through Hole						✓	✓	✓			✓	✓
	Blind Hole						✓		✓	✓	✓	✓	✓
SIZE	TPI	L	l ₁	l ₂	d		Number of Flutes					No. of Lobes	
3/16"	32	58.0	9.0	16.0	5.00	4.00	3	3	4	3	3	3	3
7/32"	28	62.0	9.0	17.0	5.60	4.50	3	3	4	3	3	3	3
1/4"	26	66.0	11.0	19.0	6.30	5.00	3	3	4	3	3	3	3
9/32"	26	66.0	11.0	19.0	7.10	5.60	3	3	4	3	3	3	3
5/16"	22	72.0	13.0	22.0	8.00	6.30	3	3	4	3	3	3	3
3/8"	20	80.0	15.0	24.0	10.00	8.00	3	3	4	3	3	3	3

✓ : Indicates availability in ready stock.

BSF

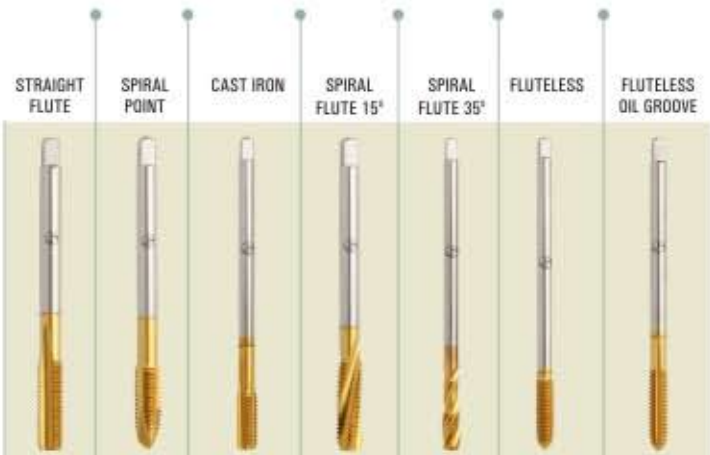
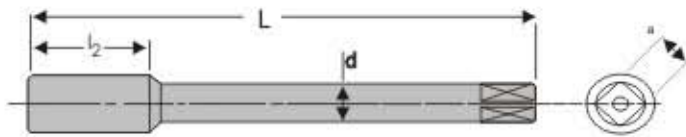

IS 6175 III, BS-949 & ISO 529

Standard Tap - HSS

High Performance Tap - HSS-E

Type of Hole
 Through Hole
 Blind Hole

Tap Type	STRAIGHT FLUTE	SPIRAL POINT	CAST IRON	SPIRAL FLUTE 15°	SPIRAL FLUTE 35°	FLUTELESS	FLUTELESS OIL GROOVE
Standard Tap - HSS	✓	✓		✓	✓		
High Performance Tap - HSS-E	✓	✓	✓	✓	✓	✓	✓
Through Hole	✓	✓	✓			✓	✓
Blind Hole	✓		✓	✓	✓	✓	✓

SIZE	TPI	L	l ₂	d		Number of Flutes					No. of Lobes	
7/16"	18	85.0	25.0	8.00	6.30	4	3	4	3	3	4	4
1/2"	16	89.0	29.0	9.00	7.10	4	3	4	3	3	4	4
9/16"	16	95.0	30.0	11.20	9.00	4	3	4	4	4	4	4
5/8"	14	102.0	32.0	12.50	10.00	4	3	4	4	4	4	4
11/16"	14	112.0	37.0	14.00	11.20	4	3	4	4	4	4	4
3/4"	12	112.0	37.0	14.00	11.20	4	3	4	4	4	4	4
7/8"	11	118.0	38.0	16.00	12.50	4	4	4	4	4	4	4
1"	10	130.0	45.0	18.00	14.00	4	4	4	4	4	4	4
1.1/8"	9	138.0	48.0	20.00	16.00	6	4	6	6	6	6	6
1.1/4"	9	151.0	51.0	22.40	18.00	6	4	6	6	6	6	6
1.3/8"	8	162.0	57.0	25.00	20.00	6	4	6	6	6	6	6
1.1/2"	8	170.0	60.0	28.00	22.40	6	4	6	6	6	6	6
1.5/8"	8	170.0	60.0	28.00	22.40	6	6	6	6	6	6	6
1.3/4"	7	187.0	67.0	31.50	25.00	6	6	6	6	6	6	6
2"	7	200.0	70.0	35.50	28.00	6	6	6	6	6	6	6

IS 6175 IV, BS-949 & ISO 2283

SIZE	TPI	L	l ₂	d		Number of Flutes					No. of Lobes	
3/16"	32	79.0	16.0	4.00	3.15	3	3	4	3	3	3	3
7/32"	28	84.0	17.0	4.00	3.15	3	3	4	3	3	3	3
1/4"	26	89.0	19.0	4.50	3.55	3	3	4	3	3	3	3
9/32"	26	89.0	19.0	5.60	4.50	3	3	4	3	3	3	3
5/16"	22	97.0	22.0	6.30	5.00	3	3	4	3	3	3	3
3/8"	20	108.0	24.0	8.00	6.30	3	3	4	3	3	3	3
7/16"	18	115.0	25.0	8.00	6.30	4	3	4	3	3	4	4
1/2"	16	119.0	29.0	9.00	7.10	4	3	4	3	3	4	4
9/16"	16	127.0	30.0	11.20	9.00	4	3	4	3	3	4	4
5/8"	14	137.0	32.0	12.50	10.00	4	3	4	3	3	4	4
11/16"	14	149.0	37.0	14.00	11.20	4	3	4	3	3	4	4
3/4"	12	149.0	37.0	14.00	11.20	4	3	4	3	3	4	4

✓ : Indicates availability in ready stock.

NPS / NPSF

■ BS 949 & ANSI

Type of Thread : ISO Inch NPS/NPSF Thread.
 Standard Tap - HSS
 High Performance Tap - HSS-E

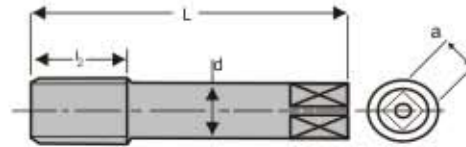

SIZE	TPI	L	l_2	D		No. of Flutes	STD
1/16"	27	53.98	17.46	7.92	5.94	4	ANSI
1/16"	27	53.98	17.46	8.07	6.04	4	BS949
1/8"	27	53.98	19.05	11.10	8.33	4	ANSI
1/8"	27	53.98	19.05	8.07	6.04	4	BS949
1/4"	18	61.91	26.99	14.27	10.69	4	ANSI
1/4"	18	61.91	26.99	10.89	8.17	4	BS949
3/8"	18	65.09	26.99	17.78	13.48	4	ANSI
3/8"	18	65.09	26.99	13.76	10.31	4	BS949
1/2"	14	79.38	34.93	17.45	13.08	4	ANS
3/4"	14	82.55	34.93	23.01	17.24	4	ANSI
1"	11.5	95.25	44.45	28.57	21.41	6	ANSI
1 1/4"	11.5	101.60	44.45	33.32	24.99	6	ANSI
1 1/2"	11.5	107.95	44.45	38.10	28.57	6	ANSI
2"	11.5	114.30	44.45	47.62	35.71	6	ANSI

• Extra Long 6" NPS/NPSF Taps in the range : 1/8" to 3/4" is available in HSS



NPT / NPTF

■ BS 949 & ANSI

Type of Thread : ISO Inch NPT/NPTF Thread.
 Standard Tap - HSS
 High Performance Tap - HSS-E

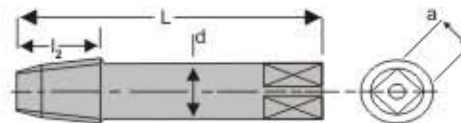

SIZE	TPI	L	l_2	D		No. of Flutes	STD
1/16"	27	53.98	17.46	7.92	5.94	4	ANSI
1/16"	27	53.98	17.46	8.07	6.04	4	BS949
1/8"	27	53.98	19.05	11.10	8.33	4	ANSI
1/8"	27	53.98	19.05	8.07	6.04	4	BS949
1/4"	18	61.91	26.99	14.27	10.69	4	ANSI
1/4"	18	61.91	26.99	10.89	8.17	4	BS949
3/8"	18	65.09	26.99	17.78	13.48	4	ANSI
3/8"	18	65.09	26.99	13.76	10.31	4	BS949
1/2"	14	79.38	34.93	17.45	13.08	4	ANSI
3/4"	14	82.55	34.93	23.01	17.24	5	ANSI
1"	11.5	95.25	44.45	28.57	21.41	5	ANSI
1 1/16"	11.5	101.60	44.45	33.32	24.99	5	ANSI
1 1/8"	11.5	107.95	44.45	38.10	28.57	7	ANSI
2"	11.5	114.30	44.45	47.62	35.71	7	ANSI
2 1/2"	8	139.70	65.09	57.15	42.85	8	ANSI
3"	8	152.40	66.68	66.67	49.98	8	ANSI
3 1/2"	8	165.10	68.26	71.42	53.54	8	ANSI
4"	8	171.45	69.85	76.20	57.15	10	ANSI

- Extra Long 6" NPT Taps in the range : 1/8" to 3/4" are available in HSS & HSS-E
- NPT Tap are available in low (15°) & Fast (35°) Spiral Flute in the range : 1/8" to 3/4" confirming to DIN Standard in HSS-E.
- Interrupted NPT Tap in the range : 1/4" to 1" are available in HSS & HSS-E



BSP / BSPT

BS 949

Type of Thread : ISO Inch BSP/BSPT Thread.
 Standard Tap - HSS
 High Performance Tap - HSS-E

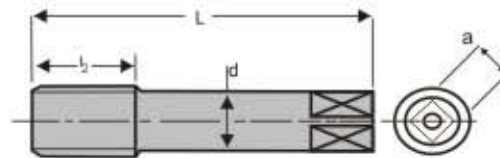

SIZE	TPI	L	l_2	D		No. of Flutes	No. of Lobes
1/8"	28	59.00	15.00	8.0	6.3	4	4
1/4"	19	67.00	19.00	10.0	8.0	4	6
3/8"	19	75.00	21.00	12.5	10.0	4	6
1/2"	14	87.00	26.00	16.0	12.5	4	8
5/8"	14	91.00	26.00	18.0	14.0	4	8
3/4"	14	96.00	28.00	20.0	16.0	4	8
7/8"	14	102.00	29.00	22.4	18.0	4	8
1"	11	109.00	33.00	25.0	20.0	4	8
1 1/4"	11	119.00	36.00	31.5	25.0	6	-
1 1/2"	11	125.00	37.00	35.5	28.0	6	-
1 3/4"	11	132.00	39.00	35.5	28.0	6	-
2"	11	140.00	41.00	40.0	31.5	6	-

- Extra Long 6" BSP Taps in the range : 1/16" to 3/4" are available in HSS
- BSP Tap are available in low (15°) & Fast (35°) Spiral Flute in the range : 1/8" to 3/4" confirming to IS & BS-949 Standard in HSS-E.
- BSP taps with special geometry for Cast iron and marked as "CI" is available in the range : 1/8 - 3/4 confirming to ISO Standard in HSS-E.
- BSPT taps with special geometry for Cast iron and marked as "CI" is available in the range : 1/8 - 3/4 confirming to BS-949 Standard in HSS-E.



HELICOIL STI TAP

ISO 2

Type of Thread : ISO 2 STI Thread.
 Standard Tap - HSS
 High Performance Tap - HSS-E

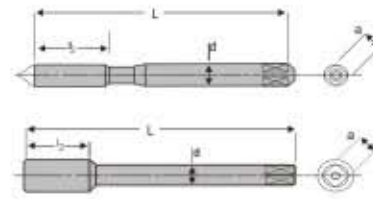

SIZE	PITCH	L	l _f	d		No. of Flutes	No. of Lobes
M 2	0.40	44.5	9.5	2.8	2.24	3	4
M 2.5	0.45	48.0	11.0	3.15	2.50	3	4
M 3	0.50	53.0	13.0	4.0	3.15	3	4
M 3.5	0.60	53.0	13.0	4.5	3.55	3	4
M 4	0.70	58.0	16.0	5.0	4.00	3	4
M 5	0.80	66.0	19.0	6.3	5.00	3	4
M 6	1.00	72.0	22.0	8.0	6.30	3	4
M 7	1.00	72.0	22.0	9.0	7.10	3	5
M 8	1.25	80.0	24.0	10.0	8.00	3	5
M 8	1.00	80.0	24.0	10.0	8.00	3	5
M 9	1.25	85.0	25.0	8.0	6.30	3	5
M 10	1.50	89.0	29.0	9.0	7.10	3	5
M 10	1.25	85.0	25.0	8.0	6.30	3	5
M 10	1.00	85.0	25.0	8.0	6.30	3	5
M 11	1.50	89.0	29.0	9.0	7.10	3	6
M 12	1.75	95.0	30.0	11.2	9.00	3	6
M 12	1.50	95.0	30.0	11.2	9.00	3	6
M 12	1.25	95.0	30.0	11.2	9.00	3	6
M 12	1.00	95.0	30.0	11.2	9.00	3	6
M 14	2.00	102.0	32.0	12.5	10.00	4	6
M 14	1.50	102.0	32.0	12.5	10.00	4	6
M 14	1.25	102.0	32.0	12.5	10.00	4	6
M 14	1.00	102.0	32.0	12.5	10.00	4	6
M 16	2.00	112.0	37.0	14.0	11.20	4	8
M 16	1.50	104.0	29.0	14.0	11.20	4	8
M 18	2.50	118.0	38.0	16.0	12.50	4	8
M 18	2.00	104.0	29.0	14.0	11.20	4	8
M 18	1.50	104.0	29.0	14.0	11.20	4	8
M 20	2.50	118.0	38.0	16.0	12.50	4	8
M 20	2.00	113.0	33.0	16.0	12.50	4	8
M 20	1.50	113.0	33.0	16.0	12.50	4	8
M 22	2.50	130.0	45.0	18.0	14.00	4	8
M 22	2.00	120.0	35.0	18.0	14.00	4	8
M 22	1.50	120.0	35.0	18.0	14.00	4	8
M 24	3.00	138.0	48.0	20.0	16.00	4	8
M 24	2.00	127.0	37.0	20.0	16.00	4	8
M 24	1.50	120.0	35.0	18.0	14.00	4	8



- Helicoil STI Tap are available as Hand Tap in the range : M2 to M24 in HSS & HSS-E
- Helicoil STI Tap are available as Fluteless Tap in the range : M3 to M16 in HSS-E

NIB TAP

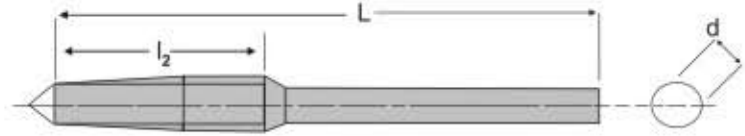

High Performance Tap - HSS-E

SIZE	PITCH	L	L ₂	D	No. of Flutes
M3	0.50	60	13	2.30	3
M4	0.70	60 - 65	18	3.00	3
M5	0.80	65 - 70	20	3.80	3
M6	1.00	70 - 75	25	4.50	3
M7	1.00	70 - 75	25	5.50	3 - 5
M8	1.00	77	25	6.40	3 - 5
M8	1.25	77 - 90	32	6.05	3 - 5
M10	1.00	90 - 95	25	8.40	3 - 5
M10	1.25	90 - 95	32	8.10	3 - 5
M10	1.50	90 - 95	38	7.80	3 - 5
M12	1.25	102	32	10.10	3 - 5
M12	1.50	102	38	9.80	3 - 5
M12	1.75	102	44	9.50	3 - 5
M14	1.00	114	25	12.30	3 - 5
M14	1.50	114	38	11.80	3 - 5
M14	2.00	114	50	11.20	3 - 5
M16	1.00	127	25	14.30	3 - 5
M16	1.50	127	38	13.80	3 - 5
M16	2.00	127	50	13.10	3 - 5

- Thread Forms : Metric Coarse, Metric Fine, UNC, UNF are standard. Other Thread Forms like BSW, BSF, BSP etc. are against special orders.
- Range : Metric sizes from 3 mm to 25 mm
Fractional sizes from 1/8" to 1"





TECHNICAL INFORMATION & GUIDELINES

NOMENCLATURE OF THREAD SYMBOLS

S.N	THREAD SYMBOLS	KIND OF THREADS
1	MC	METRIC SCREW THREADS, COARSE SERIES
2	MF	METRIC SCREW THREADS, FINE SERIES
3	UNC	UNIFIED THREAD, COARSE SERIES
4	UNF	UNIFIED THREADS, FINE SERIES
5	BSW	BRITISH STANDARD WHITWORTH COARSE THREADS
6	BSF	BRITISH STANDARD FINE THREADS
7	BSP	BRITISH STANDARD PIPE PARALLEL THREADS
8	BSPT	BRITISH STANDARD PIPE TAPER THREADS
9	NPT	AMERICAN STANDARD TAPER PIPE THREADS FOR GENERAL USE
10	NPTF	DRYSEAL AMERICAN STANDARD TAPER PIPE THREADS
11	NPS	AMERICAN STANDARD STRAIGHT PIPE THREADS
12	NPSF	DRYSEAL AMERICAN STANDARD FUEL INTERNAL STRAIGHT PIPE THREADS

STEEL FOR TAPS

The steel extensively used for production of taps is HSS-M2. But for high-speed tapping and specific applications, superior steel is used and the tap made of such steel is normally marked as HSS-E. The steel used in the manufacture of ET thread cutting tools are finest obtainable having carefully controlled metallurgical parameters with right composition which is again refined through active research and development as per stringent quality requirement imposed on all suppliers by believing in the ET's core belief "Technological advancement is a continuous process". The high alloy content and specialized In-House Heat Treatment cycles employed by ET in production gives "Red Hardness", a property enabling tools to cut without loss of hardness or rapid blunting of the cutting edges. The Powder Metallurgy Cobalt and high Vanadium alloyed steel grades are used to provide even greater resistance for tough application. The main steels used by ET thread cutting tools include:

Grades	Chemical Composition Analysis, %						Characteristics and Applications
	C	Cr	Mo	W	Co	V	
M2	0.90	4.2	5.0	6.4	---	1.8	Grade for general applications, rolls included.
M35	0.93	4.2	5.0	6.4	4.8	1.8	Grade for general applications like taps and dies.
ASP 2030	1.28	4.2	5.0	6.4	8.5	3.1	Co grade for high performance cutting tools.
ASP 2052	1.6	4.8	2.0	10.5	8.0	5.0	High W - alloyed grade for high performance.
M9V	1.2	4.2	8.5	3.5	---	2.7	Grade with high wear resistance for general applications.

SURFACE COATING

ET taps are made of the finest high speed steel and they are heat treated under controlled conditions using the latest techniques. The result is the finest range of ground thread taps to be found in the market and every tap has built-in resistance to heat and abrasion. However, there are certain tap applications where additional surface treatment can add appreciably to the life of the tap even while operating at much higher parameters. Listed below are the surface treatments currently available with us:

Coating Composition	Micro Hardness (HV)	Coefficient of friction against Steel (Dry)	Coating Thickness (Micron)	Maximum Working Temp. in C	Coating Colour	Purpose	Primary Application
Titanium Nitride(TiN)	2300	0.4	1.4	600	Gold	To resist abrasion and chip welding.	Machining of ferrous material, metal forming, Plastic molding.
Titanium Carbonitride (TiCN)	3000	0.4	1.4	400	Blue Grey	High wear resistance, enhanced toughness, wear resistance.	For mechanically stressed cutting edges, difficult to machine Ferrous and Non Ferrous ally, high speed cutting where moderate temp. generated at the cutting edge, metal forming, punching and fine blanking.
Multilayer Titanium Aluminum Nitride (Advanced Version of FUTURA) (TiN + TiAlN)	3300	0.3-0.35	1.5	900	Violet Grey	High wear resistance, excellent oxidation resistance, heat protection	A Multilayer coating designed for wide range of carbide, cermet and HSS tooling. Excellent for machining cast iron, stainless steel, nickel based high temperature alloys. Superior coating for Aluminium and Magnesium die casting.

TOLERANCES FOR SCREWING TAPS & CLASS OF FIT FOR ISO METRIC THREADS

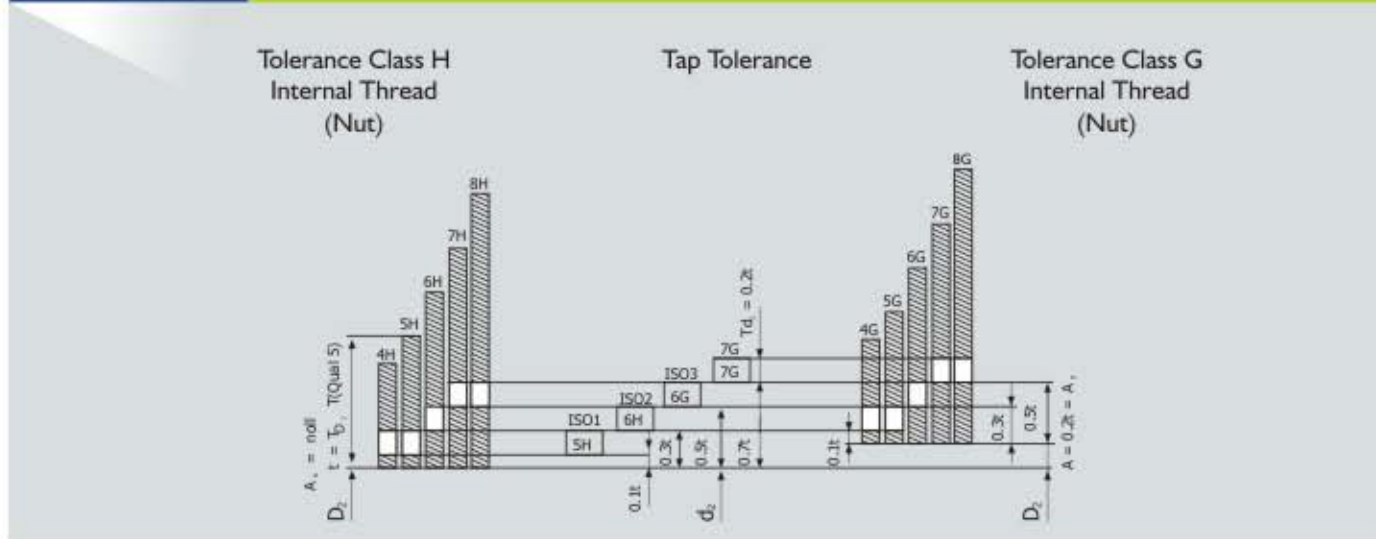

CLASS OF FIT FOR AMERICAN THREADS (UNC, UNF, NC, NF)

Screw threads are designated by the following classes of Fits Classes: -

1A, 2A and 3A for external threads (bolt).

1B, 2B and 3B for internal threads (nut).

Application:

1A and 1B: - Fit giving easy and quick assembly even when these threads are dirty or bruised. It is as good as free fit.

2A and 2B: - Suited for the vast majority of commercial fasteners, general application etc. It is as good as medium fit.

3A and 3B: - No allowance is provided for. This is used when requiring tolerance is closer than 2A and 2B. As good as close fit.

Tolerance Class Tap			Tolerance Internal Thread				
ISO	DIN	ANSI BS	4H	5H	6H	7H	8H
ISO 1	4H	3B					
ISO 2	6H	2B	4G	5G	6H		
ISO 3	6G	1B			6G	7H	8H
-	7G	-				7G	8G

CLASS OF FIT FOR BRITISH THREADS

(BSW, BSF, BA)

Screw threads are designated by the following classes of fits:

Zone 1 Zone 2 Zone 3

Application:

Zone 4: - They are for the nut taps. This is freer than Zone 3.

Zone 3: - For easier and quick assembly, it is as good as free fit.

Zone 2: - Suited for a vast majority of commercial fasteners, general applications etc. It is as good as medium fit.

Zone 1: - No allowance is provided for. This is used when requiring tolerance closer than Zone 2. As good as close fit.

DRILL SELECTION CHART

(FOR THREAD CUTTING AND THREAD FORMING TAP - Metric and Unified Threads)

ISO METRIC COARSE THREAD				ISO METRIC FINE THREAD				UNIFIED COARSE THREAD				UNIFIED FINE THREAD			
TAP Size (mm)	PITCH in mm	Drill Size		TAP Size (mm)	PITCH in mm	Drill Size		TAP Size (in)	TPI	Drill Size		TAP Size (in)	TPI	Drill Size	
		Thread cutting	Thread forming			Thread cutting	Thread forming			Thread cutting	Thread forming			Thread cutting	Thread forming
M1.6	0.35	1.25	1.45	M3	0.35	2.65	2.85	Nr.2	56	1.80	1.97	Nr.2	64	1.90	2.00
M1.7	0.35	1.35	1.55	M3.5	0.35	3.20	3.30	Nr.4	40	2.35	2.55	Nr.3	56	2.10	2.30
M1.8	0.35	1.45	1.65	M4	0.50	3.50	3.80	Nr.5	40	2.65	2.87	Nr.4	48	2.40	2.60
M2	0.40	1.60	1.82	M5	0.50	4.50	4.80	Nr.6	32	2.85	3.15	Nr.5	44	2.70	2.90
M2.2	0.45	1.75	2.00	M6	0.50	5.50	5.80	Nr.8	32	3.50	3.80	Nr.6	40	2.95	3.20
M2.3	0.45	1.90	2.10	M7	0.75	6.30	6.70	Nr.10	24	3.90	4.30	Nr.8	36	3.50	3.85
M2.5	0.45	2.05	23.00	M8	0.50	7.50	7.80	Nr.12	24	4.50	5.00	Nr.10	32	4.10	4.45
M2.6	0.45	2.10	2.40	M8	1.00	7.00	7.55	1/4"	20	5.10	5.75	Nr.12	28	4.70	5.05
M3	0.50	2.50	2.80	M9	1.00	8.00	8.55	5/16"	18	6.60	7.25	1/4"	28	5.50	5.90
M3.5	0.60	2.90	3.25	M10	0.75	9.30	9.65	3/8"	16	8.00	8.75	5/16"	24	6.90	7.45
M4	0.70	3.30	3.70	M10	1.00	9.00	9.55	7/16"	14	9.40	10.20	3/8"	24	8.50	9.00
M5	0.80	4.20	4.65	M10	1.25	8.80	9.40	1/2"	13	10.80	11.70	7/16"	20	9.90	10.50
M6	1.00	5.00	5.55	M12	1.00	11.00	11.55	9/16"	12	12.20	13.30	1/2"	20	11.50	12.10
M7	1.00	6.00	6.55	M12	1.25	10.50	11.30	5/8"	11	13.50	14.80	9/16"	18	12.90	15.20
M8	1.25	6.80	7.40	M14	1.00	13.00	13.55	3/4"	10	16.50	18.00	5/8"	18	14.50	18.30
M9	1.25	7.80	8.50	M14	1.50	12.50	13.30	7/8"	9	19.50		3/4"	16	17.50	
M10	1.50	8.50	9.30	M16	1.00	15.00	15.55	1"	8	22.50		7/8"	14	20.50	
M12	1.75	10.30	11.20	M16	1.50	14.50	15.30	1.1/8"	7	25.00		1"	12	23.50	
M14	2.00	12.00	13.10	M18	1.00	17.00	17.55	1.1/4"	7	28.00		1.1/8"	12	26.50	
M16	2.00	14.00	15.10	M18	1.50	16.50	17.30	1.3/8"	6	30.50		1.1/4"	12	29.50	
M18	2.50	15.50	16.90	M20	1.50	18.50	19.30	1.1/2"	6	34.00		1.3/8"	12	33.00	
M20	2.50	17.50	18.90	M22	1.50	20.50						1.1/2"	12	36.00	
M22	2.50	19.50		M24	1.00	23.00									
M24	3.00	21.00		M24	1.50	22.56									
M27	3.00	24.00		M25	1.00	24.00									
M30	3.50	26.50		M26	1.50	24.50									
M33	3.50	29.50		M27	1.50	25.50									
M36	4.00	32.00		M28	1.50	26.50									
M39	4.00	35.00		M30	1.50	28.50									
M42	4.50	37.50		M33	2.00	31.00									
M45	4.50	40.50		M35	1.50	33.50									
				M36	3.00	33.00									

Note : - Drill Sizes are in mm-For other sizes not in above table formula as follows (In Metric System): 1) Drill Size for Fluted Tap = Tap Size -Pitch
2) Drill Size for Fluteless Tap = Tap Size - (0.0068 x 65 x Pitch)

DRILL SELECTION CHART

(For Withworth and Pipe Threads)

BSW THREAD			BSF THREAD			BSP THREAD				BSPT THREAD			NPT / NPTF THREAD			
TAP Size	TPI	Drill Size (Thread cutting)	TAP Size	TPI	Drill Size (Thread cutting)	TAP Size	TPI	Drill Size		TAP Size	TPI	Drill Size (Thread cutting)	TAP Size	TPI	Drill Size	
								Thread cutting	Thread forming						NPT	NPTF
1/16"	60	1.20	3/16"	32	4	1/8"	28	8.80	9.30	1/8"	28	8.40	1.16"	27	6.30	6.20
3/32"	48	1.90	7/32"	28	4.6	1/4"	19	11.80	12.50	1/4"	19	11.20	1/8"	27	8.50	8.40
1/8"	40	2.50	1/4"	26	5.3	3/8"	19	15.25	16.00	3/8"	19	14.75	1/4"	18	11.00	10.90
5/32"	32	3.20	9/32"	26	6	1/2"	14	19.00	20.10	1/2"	14	18.25	3/8"	18	14.50	14.25
3/16"	24	3.60	5/16"	22	6.8	5/8"	14	21.00		5/8"	14	20.25	1/2"	14	18.00	17.75
7/32"	24	4.50	3/8"	20	8.3	3/4"	14	24.50		3/4"	14	23.75	3/4"	14	23.00	23.00
1/4"	20	5.10	7/16"	18	9.7	7/8"	14	28.00		7/8"	14	27.50	1"	11.1/2	29.00	29.00
9/32"	20	5.80	1/2"	16	11.1	1"	11	30.50		1"	11	30.00	1.1/4"	11.1/2	38.00	37.75
5/16"	18	6.50	9/16"	16	12.7	1.1/4"	11	39.50		1.1/8"	11	34.50	1.1/2"	11.1/2	44.00	43.75
3/8"	16	7.90	5/8"	14	14	1.1/2"	11	45.00		1.1/4"	11	38.50	2"	11.1/2	56.00	55.75
7/16"	14	9.30	11/16"	14	15.5	1.3/4"	11	51.00		1.3/8"	11	41.00	2.1/2"	8	67.00	66.50
1/2"	12	10.50	3/4"	12	16.75	2"	11	57.00		1.1/2"	11	44.50	3"	8	83.00	82.50
9/16"	12	12.10	7/8"	11	19.75	2.1/4"	11	63.00		1.3/8"	11	50.00				
5/8"	11	13.50	15/16"	11	21.5	2.1/2"	11	72.50		2"	11	56.00				
11/16"	11	15.10	1"	10	22.75	2.3/4"	11	79.00		2.1/4"	11	62.00				
3/4"	10	16.25	1.1/8"	9	25.5	3"	11	85.50		2.1/2"	11	71.50				
7/8"	9	19.25	1.1/4"	9	28.5					2.3/4"	11	78.00				
15/16"	9	20.60	1.3/8"	8	31.5					3"	11	84.00				
1"	8	22.00	1.1/2"	8	34.5											
1.1/8"	7	24.75	1.5/8"	8	37.7											
1.1/4"	7	28.00														
1.3/8"	6	30.10														
1.1/2"	6	33.50														
1.5/8"	5	35.70														
1.3/4"	5	39.00														

NPS / NPSF THREAD			
TAP Size	TPI	Drill Size	
		NPS	NPSF
1/8"	27	9.10	8.70
1/4"	18	12.00	11.30
3/8"	18	15.50	14.75
1/2"	14	19.00	18.25
3/4"	14	24.50	23.50
1"	11.1/2	30.50	29.50
1.1/4"	11.1/2	39.50	
1.1/2"	11.1/2	45.50	
2"	11.1/2	57.50	
2.1/2"	8	69.00	
3"	8	85.00	

Note : - Drill Sizes are in mm

CUTTING SPEED

FORMULA

$$Rpm = \frac{1000 \times \text{cutting speed (M/min)}}{3.14 \times \text{major dia.}}$$

$$Rpm = \frac{96.98 \times \text{cutting speed (f/min)}}{\text{major dia.}}$$

Conversion table from m/mm to rpm

Tool Diameter		PERIPHERAL CUTTING SPEED															
Meters/Min	Feet/Min	5	8	10	15	20	25	30	40	50	60	70	80	90	100	110	150
mm	Inches																
1.00		1591	2545	3182	4773	6364	7955	9545	12727	15909	19091	22273	25455	28636	31818	35000	47727
1.50		1061	1697	2121	3182	4242	5303	6364	8485	10606	12727	14848	16970	19091	21212	23333	31818
2.00		795	1273	1591	2386	3182	3977	4773	6364	7955	9545	11136	12727	14318	15909	17500	23864
2.50		636	1018	1273	1909	2545	3182	3818	5091	6364	7636	8909	10182	11455	12727	14000	19091
3.00		530	848	1061	1591	2121	2652	3182	4242	5303	6364	7424	8485	9545	10606	11667	15909
3.18	1/8	500	800	1001	1501	2001	2501	3002	4002	5003	6003	7004	8005	9005	10006	11006	15009
3.50		455	727	909	1364	1818	2273	2727	3636	4545	5455	6364	7273	8182	9091	10000	13636
4.00		398	636	795	1193	1591	1989	2386	3182	3977	4773	5568	6364	7159	7955	8750	11932
4.50		354	566	707	1061	1414	1768	2121	2828	3535	4242	4949	5657	6364	7071	7778	10606
4.76	3/16	334	535	668	1003	1337	1671	2005	2674	3342	4011	4679	5348	6016	6684	7353	10027
5.00		318	509	636	955	1273	1591	1909	2545	3182	3818	4455	5091	5727	6364	7000	9545
6.00		265	424	530	795	1061	1326	1591	2121	2652	3182	3712	4242	4773	5303	5833	7955
6.35	1/4	251	401	501	752	1002	1253	1503	2004	2505	3006	3508	4009	4510	5011	5512	7516
7.00		227	364	455	682	909	1136	1364	1818	2273	2727	3182	3636	4091	4545	5000	6818
7.94	5/16	200	321	401	601	801	1002	1202	1603	2004	2404	2805	3206	3607	4007	4408	6011
8.00		199	318	398	597	795	994	1193	1591	1989	2386	2784	3182	3580	3977	4375	5966
9.00		177	283	354	530	707	884	1061	1414	1768	2121	2475	2828	3182	3535	3889	5303
9.53	3/8	167	267	334	501	668	835	1002	1336	1669	2003	2337	2671	3005	3339	3673	5008
10.00		159	255	318	477	636	795	955	1273	1591	1909	2227	2545	2864	3182	3500	4773
11.00		145	231	289	434	579	723	868	1157	1446	1736	2025	2314	2603	2893	3182	4339
11.11	7/16	143	229	286	430	573	716	859	1146	1432	1718	2005	2291	2578	2864	3150	4296

CUTTING SPEED

cont.

Conversion table from m/mm to rpm

Meters/Min	5	8	10	15	20	25	30	40	50	60	70	80	90	100	110	150
Feet/Min	16.4	26.2	32.8	49.2	65.6	82.0	98.4	131.2	164.0	196.9	229.7	262.5	295.3	328.1	360.9	492.1
PERIPHERAL CUTTING SPEED																
12.00	133	212	265	398	530	663	795	1061	1326	1591	1856	2121	2386	2652	2917	3977
12.00	133	212	265	398	530	663	795	1061	1326	1591	1856	2121	2386	2652	2917	3977
12.70	125	200	251	376	501	626	752	1002	1253	1503	1754	2004	2255	2505	2756	3758
13.00	122	196	245	367	490	612	734	979	1224	1469	1713	1958	2203	2448	2692	3671
14.00	114	182	227	341	455	568	682	909	1136	1364	1591	1818	2045	2273	2500	3409
14.29	111	178	223	334	445	557	668	891	1113	1336	1559	1781	2004	2227	2449	3340
15.00	106	170	212	318	424	530	636	848	1061	1273	1485	1697	1909	2121	2333	3182
15.88	100	160	200	301	401	501	601	801	1002	1202	1403	1603	1803	2004	2204	3006
16.00	99	159	199	298	398	497	597	795	994	1193	1392	1591	1790	1989	2188	2983
17.00	94	150	187	281	374	468	562	749	936	1123	1310	1497	1684	1872	2059	2807
17.46	91	146	182	273	364	456	547	729	911	1093	1276	1458	1640	1822	2005	2734
18.00	88	141	177	265	354	442	530	707	884	1061	1237	1414	1591	1768	1944	2652
19.05	84	134	167	251	334	418	501	668	835	1002	1169	1336	1503	1670	1837	2505
20.00	80	127	159	239	318	398	477	636	795	955	1114	1273	1432	1591	1750	2386
22.00	72	116	145	217	289	362	434	579	723	868	1012	1157	1302	1446	1591	2169
22.22	72	115	143	215	286	358	430	573	716	859	1002	1146	1289	1432	1575	2148
24.00	66	106	133	199	265	331	398	530	663	795	928	1061	1193	1326	1458	1989
25.00	64	102	127	191	255	318	382	509	636	764	891	1018	1145	1273	1400	1909
25.40	63	100	125	188	251	313	376	501	626	752	877	1002	1127	1253	1378	1879
27.00	59	94	118	177	236	295	354	471	589	707	825	943	1061	1178	1296	1768
30.00	53	85	106	159	212	265	318	424	530	636	742	848	955	1061	1167	1591
32.00	50	80	99	149	199	249	298	398	497	597	696	795	895	994	1094	1491
34.00	47	75	94	140	187	234	281	374	468	562	655	749	842	936	1029	1404
36.00	44	71	88	133	177	221	265	354	442	530	619	707	795	884	972	1326
38.00	42	67	84	126	167	209	251	335	419	502	586	670	754	837	921	1256
40.00	40	64	80	119	159	199	239	318	398	477	557	636	716	795	875	1193
45.00	35	57	71	106	141	177	212	283	354	424	495	566	636	707	778	1061
50.00		32	51	64	95	127	159	191	255	318	382	445	509	573	636	

Effect of lubricants on the Cutting Process

Heat is generated as a result of the machining operation done in cutting metals. This heat reduces the hardness of the cutting tools. By means of cutting fluids, the impact of the heat thus generated during machining is reduced and the friction between the tool, chips and between the tool and the workpiece is also reduced.

The advantages of using the correct cutting fluid are :

1. Longer tool life.
2. Greater production.
3. Better size control.
4. Smoother and more accurate finish.
5. Avoids frequent resharping of tap.
6. More efficient removal of chips.

The best cutting fluid is the one that possesses good lubricating properties in addition to its cooling properties.

Unfortunately, many tap users do not appreciate the important role played by fluids in the tapping operations. The users of tap can take advantage of the services and the recommendations offered by our Application Engineers.



General Suggestions Concerning Do & Don't's For Tapping

1. For better thread tolerance control, finish & maximize Tap performance

- a) The spindle of the tapping machines and the tapping head should be free from run out and play. A simple check should ensure that the spindle is running true.
 - b) It is common practice to use a FLOATING HOLDER, which allows the tap to align itself with the drilled hole.
 - c) Never tap through a BUSHING because the crest of the tap might get damaged due to contact with the bushing.
 - d) Countersinking the hole prior to tapping will facilitate easy entry of the tap, especially in the case of bottoming tap. Countersinking is also helpful when tapping with a fluteless tap.
 - e) Care should be taken during reversal of the tap as most of the time, the problem occurs during tap reversal. To some extent the problem can be sorted out by adjusting the feed control and speed while reversing. The tap should not come out with a jerk, this may damage the threads or may affect its finish.
 - f) TAPPING HOLDERS : Many tapping problems can be eliminated by going for a good reversible tapping attachment which should have features like Torque Control, Self Feed Auto reverse, Axial Cushioning effect, Radial Float and it should be light in weight.
2. While tapping in Punched Holes in sheet metals, it often causes bending or loading and the tap may break. When the hole is punched the metal is flayed out and this will affect while the tap is being reversed.

3. CHECK LIST WHEN USING ROLL FORM TAPS

- a) Proper selection of the correct drill size for pre-tapped holes.
- b) Countersink or chamfer the hole to avoid the possible deposit of displaced burs at the mouth of the holes.
- c) Use a cutting oil (sulfurized or chlorinated) instead of a coolant.
- d) Coolant concentration in range of 7-9% (Emulsion Oil) gives better thread finish, closer tolerance threads along with increased Tap life.
- e) Surface Coated Taps are advisable for best result and higher productivity.
- f) For Tapping Speed, please get our advice depending upon your application.
- g) Torque requirement for Roll Form Tap is higher than those for Thread Cutting Taps and hence suitable machines should be selected.
- h) While using multi-spindle tapping machines, please check if enough torque is available.
- i) For short blind holes, caution must be exercised so that the tap does not hit the bottom which can result in breakage of tap or chipping-off of threads.

4. BEFORE TAPPING CHECK THE FOLLOWING:-

- a) Check the alignment of the drilled hole and tap.
- b) Check the coolant nozzle positioning in reference to location of drilled hole in the components where tapping is to be done while machine tapping.
- c) Use of correct coolant oil as per material of component to be tapped. In case of machine tapping ensure ample quantity of coolant with right pressure is available for wet tapping. Please get our advice depending upon your application
- d) Check whether the tap selected is suitable for the required application. Please get our advice depending upon your application.
- e) Proper clamping of component.
- f) Check size of drilled hole. Refer to our Drill Selection Chart for guidance.
- g) Selection of proper feed & speed as per material for machine tapping. Please get our advice depending upon your application.
- h) Proper countersink/chamfer is provided in the drilled hole which needs to be tapped.
- i) Ensure Tap is secured properly & firmly without any run-out.
- j) No run-out in spindle in the machine used for tapping.
- k) Tap holding device is secured properly with no play.



Problem	Possible Cause	Solution
Oversize thread produced	Incorrect tap or tap geometry	Apply correct tap for the material to be machined. not suitable for the application. Use our selection chart. Use tap and gauge tolerances.
	Chip packing.	Use spiral point or spiral fluted taps. Reduced number of flutes to provide extra chip room. Use large hole size. If tapping a blind hole, allow a deeper hole where applicable or shorten the thread length of the parts. Use a proper lubricant.
	Pretapping hole size is too small.	Use our Drill Chart for cutting or fluteless or fluteless taps as the case may be.
	Cold Welding at the flank of the tap.	Apply new tap. Apply coated tap. Optimize lubrication. Reduce tapping speed.
	Lead of tap or Rake angle of tap not correct.	Regrind tap to correct geometry.
	Cutting speed too high.	Reduce cutting speed.
	Lubrication or coolant supply insufficient.	Ensure sufficient, suitable coolant supply and that the concentration of coolant is between 3-5%.
	Operating conditions.	Apply proper tapping speed. Correct the alignment of tap and drill hole. Free cutting of either the tap or work piece. Use proper tapping machine with suitable power. Avoid the misalignment of the tap and the drill hole from the loose spindle or worn holder.
Tap breakage	Pretapping hole size is too small.	Use our Drill Chart for cutting or fluteless taps as the case may be.
	Chamfer overloaded.	Increase No. of thread of chamfer lead.
	Tap hits bottom of tapping size hole.	Check the hole depth, apply tension/compression tap chuck.
	Work hardened material.	Use a more hardened tap or a surface treated tap.
	Lack of or incorrect countersink on the	Provide proper countersink. mouth of the hole.
	Wrong alignment of tap with hole.	Check the alignment of tap & drill hole.
	Lack of lubricant or wrong type.	Improve the lubricant supply and use a right type.
	Incorrect tap, tap geometry not suitable for the application.	Use the selection chart.
	Excessive tapping torque.	Use a large drill size. Try to shorten thread length. Increase cutting angle. Apply a tap with more thread relief and reduced land width. Use spiral pointed or spiral fluted taps.
	Tool Condition.	Do not leave section on the reground flutes where tapping wear still remains. Regrind tool more frequently.



Problem	Possible Cause	Solution
Thread produced is too small	Tolerance on tap does not correspond to gauge tolerance.	Apply correct tap for required tolerance.
	Incorrect tap.	Apply correct tap for the material to be machined. Use oversize taps for cutting materials such as copper alloy, aluminium alloys and cast iron. Use oversized taps for cutting tubings which have " Spring back " action after tapping.
	Tap does not cut accurately.	Avoid axial forces during the cutting process.
	Machine spindle is axially too rigid.	Apply tension/compression chuck.
	Left over chips.	Increase cutting performance to avoid any left over chips in the hole. Remove the left over chips from the hole for gauge checking.
Oversized internal diameter	Hole size.	Use minimum hole size.
	Galling.	Avoid tapered hole by the use of proper chamfered taps. Check core sharpness of taps. Apply proper surface treatment such as stream oxide or chrome. Use proper cutting lubricants. Ensure proper cutting angles in accordance with the material being tapped.
Thread axially miscut	Spiral - Fluted Taps, if applied with too much pressure for initial tapping.	Spiral Tap requires only light pressure for initial tapping. The tap should be applied within the tension/compression range.
	Spiral pointed taps if applied with too low pressure	Taps with spiral point or left hand spiral require higher axial pressure. Ensure tap operates within the tension compression range.
Torn thread or rough thread in tapped components	Incorrect rake angle (usually too small). Pretapping hole size is too small.	Use minimum hole size. Avoid tapered hole by using proper chamfered taps. Check core sharpness of taps.
	Chips clogging between the flutes.	Use a tap with lesser number of flutes.
	Broken threads on taps.	Use a new tap.
	Improper re-sharpening of taps.	Re-sharpen the tap or use a new tap.
	Lack of lubricant, or use of wrong type.	Use right lubricant with sufficient supply.
	Chamfer too short.	Increase chamfer length.
	Galling.	Use thread relieved taps, reduced land width, apply surface treated taps, use proper cutting lubricant, reduced tapping speed, use large hole size, obtain proper alignment between tap and work



Problem	Possible Cause	Solution.
Overheating of tap	Excessive land width.	Use correct tap.
	Lack of lubricant, or use of wrong type.	Use proper lubricant with sufficient quantity.
	Dull tap.	Use new tap or re-sharpen the tap.
	Excessive flank contact, pitch diameter relief require.	Use correct tap.
	Excessive tapping speeds.	Apply the proper tapping speed.
Thread surface finish not good	Cutting edge geometry not suitable for the application.	Apply "correct" tap for the material to be machined.
	Cutting speed too high.	Reduce cutting speed.
	Insufficient coolant (concentration and supply)	Ensure suitable coolant and sufficient volume.
	Chip congestion.	Apply suitable tap type.
	Pre tapping hole size is too small.	Use our Drill Chart for cutting or, Fluteless taps as the case may be.
	Built-up edge.	Remove left over chips from the hole for gauge checking.
	Cold welding.	Improve coolant supply and increase concentration.
Tap failure on reversal	Tap cutting too tightly.	Increase rake angle.
	Tap galling.	Face angle on back of land should be increased.
	Chip wedged between flutes.	Use tap with lesser number of flutes, increase flow of lubricants, use correct tap.
Tap sticking or binding	Pretapping hole size is too small.	Use our Drill Chart for cutting or fluteless tap as the case may be.
	Tap lands too wide.	Use correct tap.
	Incorrect cutting face angle.	Use correct geometry of the tap.
	Lack of lubricant or use of wrong type.	Use proper lubricant with sufficient quantity.
Cutting face breakdown	Incorrect cutting face angle.	Use correct geometry as per application.

GUIDE TO THREAD FORMING TAP

(A different way of producing internal threads)



Also known as Cold Forming Tap or Roll Forming Tap, Thread Forming Tap produces internal threads by an action similar to Thread Rolling, a novel method of cold forming of threads by displacement of material rather than by chip removal. These taps have neither flutes nor cutting edges and they are just like a screw. In the end view and cross section, the major and minor diameters follow a CONTOUR. The fluteless taps are "Screwed" in the pre-drilled work piece with proper feed rate and the thread profile is gradually press formed (please refer to figure).

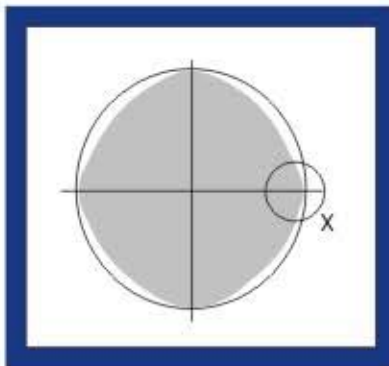

Fig. 1



Fig. 2



Fig. 3

It is a chip-less technology and any material having ductility co-efficient of 10% or less (tensile strength less than 1000N/mm²) can be machined perfectly.

A) ADVANTAGES OVER CONVENTIONAL THREAD CUTTING TAPS:

1. No chips are produced since threads are produced by cold forming process and hence the chance of tap breakage is minimized. (Chip entrapment/clogging has been identified as the major cause for tap breakage and poor quality of threads).
2. Easier BLIND HOLE Tapping because there are no chips to clog or jam at the bottom of the hole, which consequently eliminate tap breakage.
3. Strong Threads because the grain fibers are not cut but a thread is formed by displacement of material (Refer Fig (2)). The Pull Test or Torque Tension Tests demonstrate that the threads produced by Roll Form Taps are stronger (by an average of 35% more than threads produced by Thread Cutting Taps.)
4. Better control of tapped hole size. (Thread Cutting Taps may cut over size holes due to excessive downward pressure.)
5. Better surface finish and absolute accuracy of the thread is guaranteed because of Cold Forming.
6. No Threads Pitch Errors- Thread Cutting Taps may cause tearing of threads, which may cause a pitch error while reversing.
7. Faster tapping speed and increased productivity. (Tapping speeds can be more than those recommended for Cutting Taps.)
8. Increased tool life due to strong core area.
9. Consistency in tapped hole sizes from the first to the last due to continuous forming action and accurate lead.
10. Plating failures are reduced because there is no chip to stick at the bottom of blind holes or on the threads.
11. The tap has greater rigidity and better strength (Core Portion) because there are no flutes and there is less risk of breakage, especially in small sizes resulting in reduction in cost per tapped hole and increased production.
12. Application in wide range of materials like Aluminium, Steel, Stainless Steel, Copper (soft), Brass (long chipping), Magnesium, Zinc alloys etc.

B) EQUIPMENT :

Conventional tapping equipment can be used. Forming taps work very well in NC and CNC Machines, drill, lathes, lead screw tapping equipment and on many standard tapping heads.

C) OIL GROOVES:

For tapping depths more than two times the tap diameter, Roll Taps with Oil Grooves are recommended.

These grooves provide a passage for the lubricant and also for the escape of air and oil to avoid a piston effect in blind holes.

D) HOLE SIZE :

The pretapping hole size required for forming the taps is larger in conventional tapping. Accurate pretapping hole is desirable while tapping with fluteless taps. This size depends on the forming property of the material, desired depth of the thread, stripping strength requirement etc. For the conventional thread cutting tap, the hole size is identical to minor dia of the tapped internal thread. But in case of fluteless tap, the hole size is calculated as per following formula:

$$\text{HOLE SIZE} = \text{BASIC TAP OD} (0.0068 \times 65 \times \text{Pitch})$$

The general formula for determining the hole size has been given above but if necessary, fine tuning may be required after performing some actual trials etc. We are giving here under profiles of threads formed by M10 x 1.5 fluteless taps with different hole sizes.

Ø 9.10

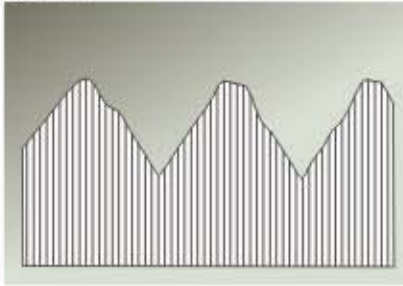

Ø 9.20

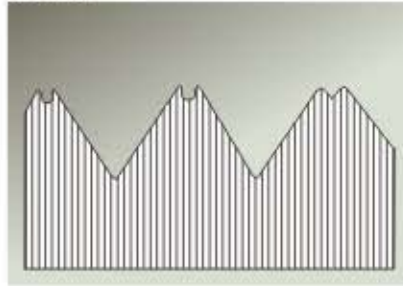

Ø 9.40

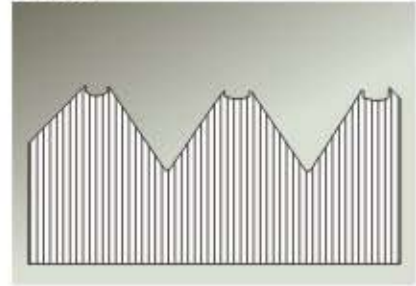

E) TORQUE :

The torque requirements for forming taps are more than those for cutting taps. The actual torque experienced will vary with the material to be formed and some experiments may be required, if torque is a limiting factor.

F) THREAD FORMS:

Metric Coarse, Metric Fine, UNC, UNF are in our standard manufacturing range. Other thread forms like BSW, BSF, BSP etc. are against orders.

G) RANGE:

1.6 mm to 24 mm and 1/8" to 1".

H) COATINGS:

Surface coatings like TiN, TiCN, TiAlN etc. are available to improve the tools life and suit different work material applications.

I) LUBRICATION:

Proper lubrication is very important in thread forming with flueless taps. Lubrication prevents material from building up on the high points of the thread flanks and ensures that the torque during thread forming process does not increase. Therefore, continuous flow of lubricant is necessary. Oils having presence of graphite such as those used in rolling processes should be preferred.

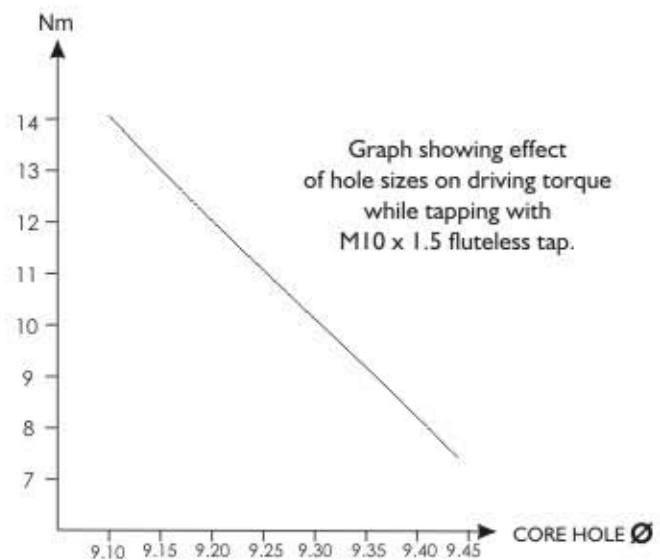

J) CHECK LIST WHEN USING ROLL FORM TAPS

1. Proper selection of the correct drill size for pre-tapped holes.
2. Countersink or chamfer the hole to avoid possible deposit of displaced burrs at the mouth of the holes.
3. Use a cutting oil (sulfurized or chlorinated) than a coolant.
4. Surface coating of taps is advisable for best result and higher productivity.
5. Tapping speed-Please get our advice, depending upon your application.
6. Torque requirement for Roll Form Tap is higher than those for Thread Cutting Taps and hence suitable machines, should be selected.
7. While using multi spindle tapping machines, please check if enough torque is available.
8. For short blind holes, caution has to be exercised that the tap does not hit at the bottom and break or chips off.





Emkay for Total Tapping Solutions

Emkay offers a complete range of taps in standards namely ISO, DIN, ANSI, BS & JIS.

Emkay taps are available in Metric threads, Unified threads, Withworth threads, Straight and Taper Pipe threads and B.A. threads. Other thread types like Acme, Stub Acme, 60 – Stub Acme, Buttress threads can also be provided as per customer's specific requirement. Non-Standard Taps as per customer drawings are also provided by Emkay on specific request.



Longer Life

Better Price

Improved Geometries

Faster Cutting Speed

Ideal For Tapping On CNC Machines



EMKAY TOOLS

B-27 & B-27/1, M.I.D.C., Industrial Area, Hingna Road, Nagpur - 440 016 (India)

Tel : 91-7104-237363, 237584, Fax : 91-7104-232862

E-mail : emkaytools@gmail.com, Website : www.emkaytools.com